



RAZER EDGE 5G BUNDLE

MASTER GUIDE

Razer Edge is custom-built to be the ultimate Android gaming handheld. The exclusive Snapdragon G3x provides unbeatable performance, the 144Hz AMOLED display offers incredible clarity at high speeds, and Kishi V2 Pro is a console quality controller for compatible Android games and Xbox Game Pass.

CONTENTS

1. WHAT'S INSIDE	3
2. LET'S GET YOU COVERED	5
3. SETTING UP YOUR RAZER EDGE.....	6
4. USING WITH RAZER KISHI V2 PRO	7
5. USING THE RAZER EDGE	9
6. CONFIGURING YOUR TABLET.....	13
7. SAFETY AND MAINTENANCE	35
8. LEGALESE.....	37

1. WHAT'S INSIDE

- Razer Edge

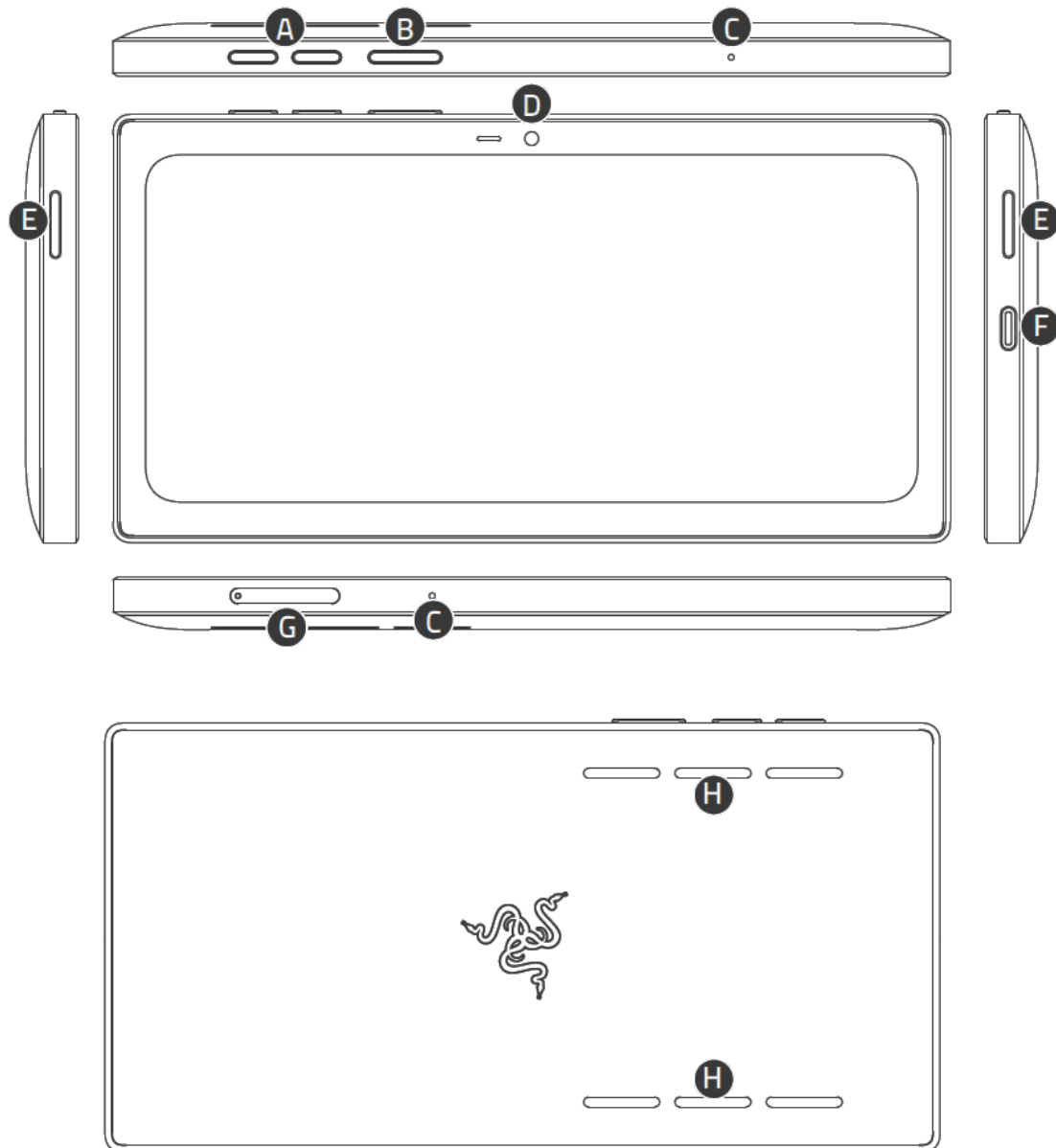

A. Multidirectional speakers

B. MicroSD card tray

C. Array microtablet

D. Front camera

E. Volume control buttons

F. Power button

G. USB Type C port

H. Air exchange chambers

- Razer Kishi V2 Pro

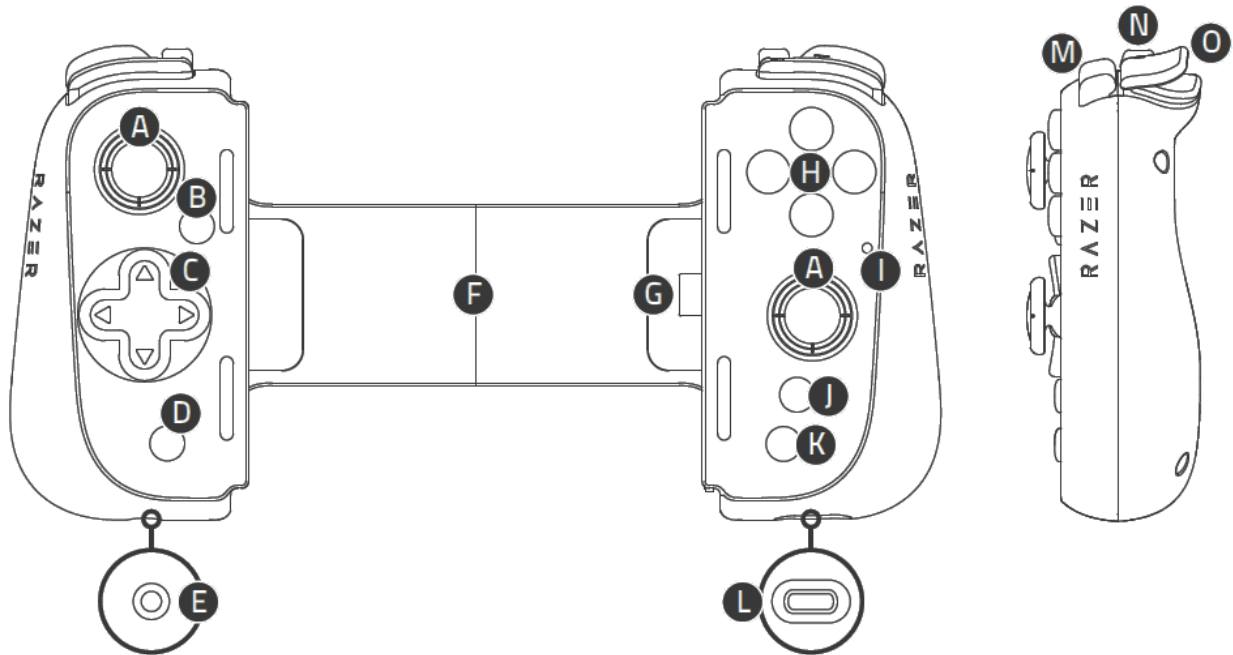

- A. Clickable analog thumbsticks (L3/R3)
- B. Options button
- C. D-pad
- D. Share button
- E. 3.5 mm headphone / microphone combo port
- F. Extendable bridge
- G. USB Type C connector

- H. Face buttons
- I. Status indicator
- J. Razer Nexus button
- K. Menu button
- L. USB Type C port
- M. Bumpers (L1/R1)
- N. Multi-function buttons (M1 / M2)
- O. Triggers (L2/R2)

- Charging cable



- Power Adapter

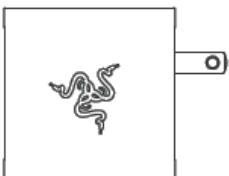

- Important Product Information Guide

2. LET'S GET YOU COVERED

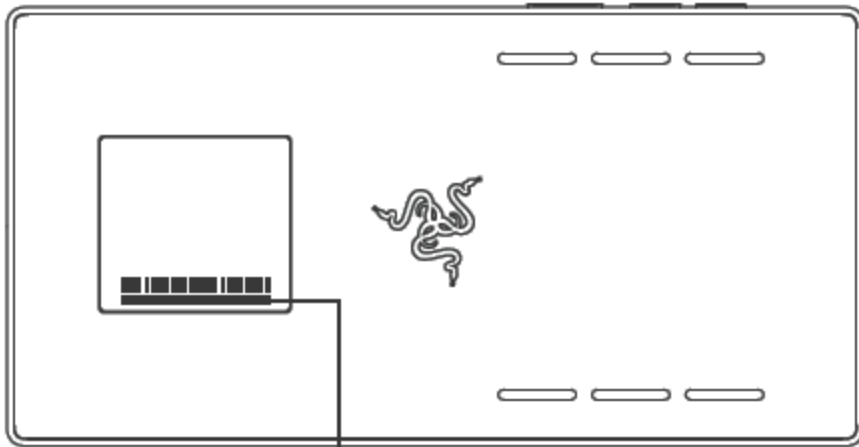

*Your product's serial number
can be found here.*



razerid.razer.com/warranty

Register your product and score exclusive benefits

Got a question? Ask the Razer Support Team at support.razer.com

3. SETTING UP YOUR RAZER EDGE

CHARGING

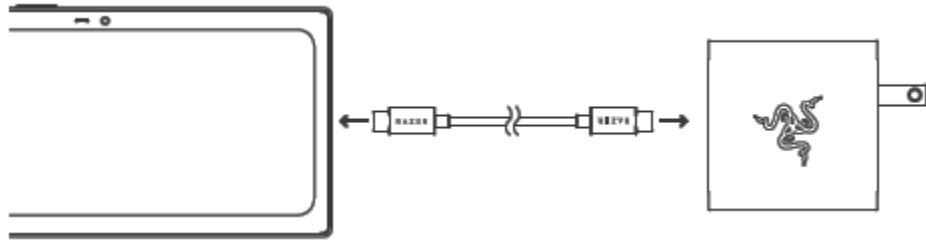

POWER ON

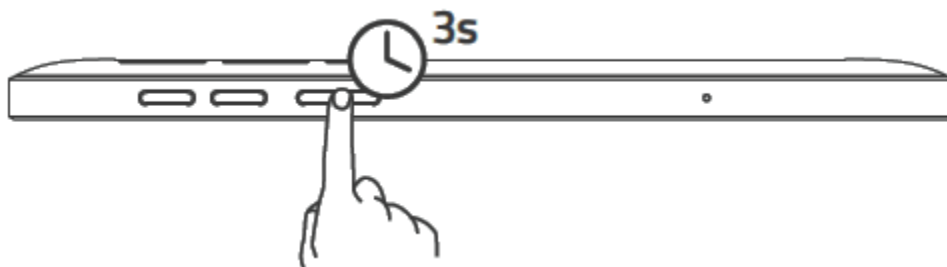

OPTIONAL UPGRADE

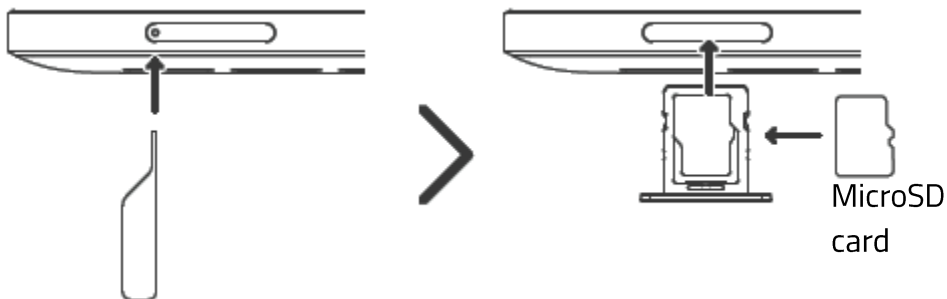

i *MicroSD card and ejector pin not included. Class 10 microSD card (up to 2TB) recommended.*

4. USING WITH RAZER KISHI V2 PRO

MOUNTING

1.

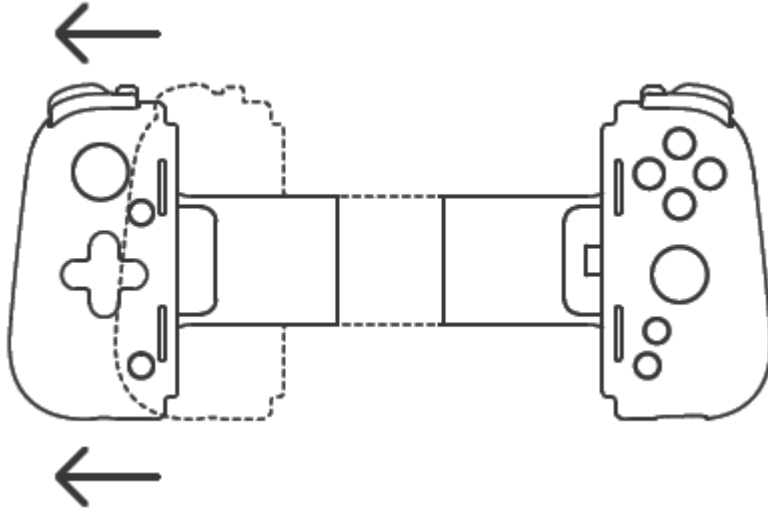

2.

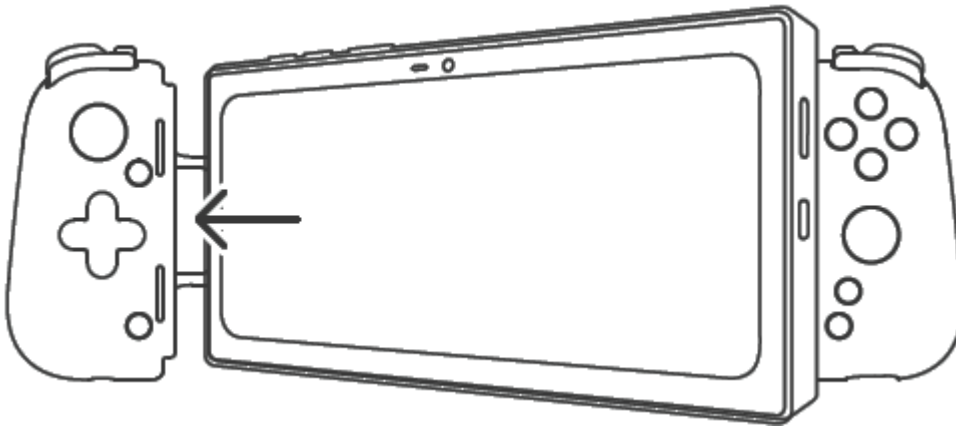

3.

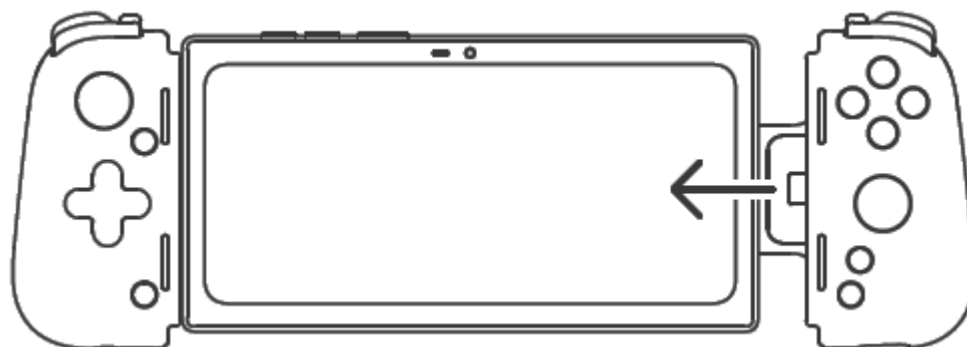

CONTROLLER CHARGING

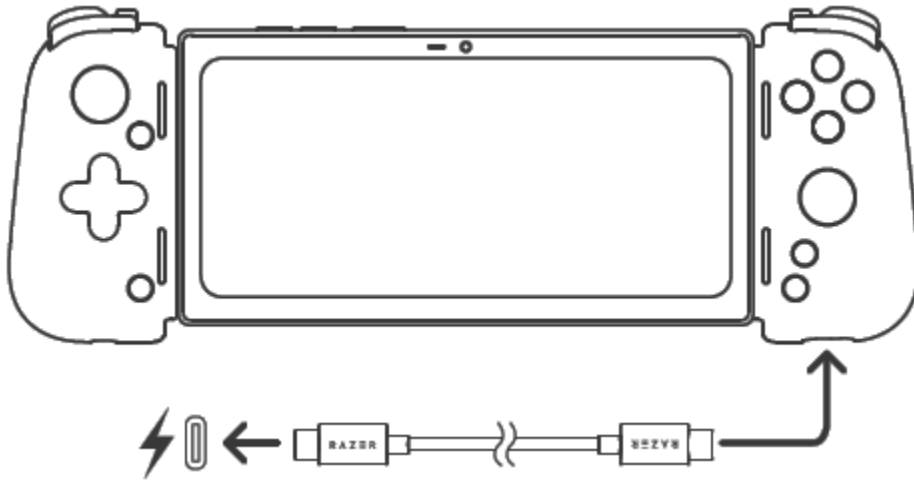

i *USB Type C audio and other accessories not supported.*

CONTROLLER AUDIO

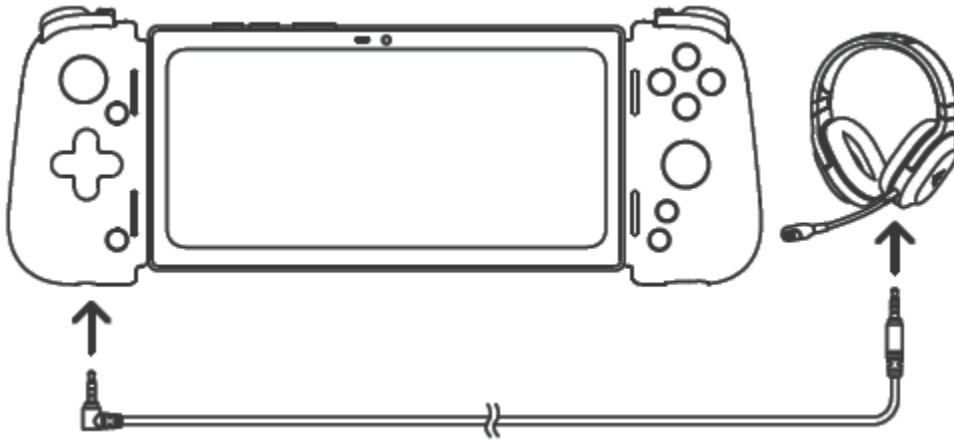

i *Razer headset sold separately.*

Find out more about your Razer product at support.razer.com

5. USING THE RAZER EDGE

DEFAULT TABLET BUTTON FUNCTIONS

- **Power Key**
 - Press to lock / unlock the tablet.
 - Double press to launch the camera app from any screen.
 - Press and hold to open the Power actions menu.
- **Volume keys**
 - Increase or decrease ring, media, and alarm sounds.
 - Press any of these from the camera app to take a photo.
- **Power Key + Low volume key**
 - Press both keys simultaneously to take a screenshot.

TOUCHSCREEN ACTIONS / GESTURES

- **Tap.** Lightly tap to select an option or item, launch a chosen app, or to enter text using the virtual keyboard.
- **Double Tap.** Lightly tap twice on an image to zoom in or out on a selected area, or text to select a word.
- **Tap and Hold.** Tap and hold an item or app to open additional options for the selected item.
- **Tap and Drag.** Tap and hold an item or app, and then move your finger to drag it to the preferred location.
- **Swipe.** Lightly tap and move your finger horizontally or vertically across the screen to move through lists, scroll through webpages, browse photos, and perform other browsing navigation.
- **Pinch and Spread.** Pinch or spread two fingers to zoom out or in on an image or on other content such as maps or webpages.

LOCKING / UNLOCKING THE SCREEN

To lock the screen, simply press the power key and the screen will turn off indicating that the screen is now locked. To unlock, simply press the power key, and then swipe up.

Note: If you have already customized your lock screen's security setting, you may need to use the screen lock setting set of your tablet.

TABLET ACTIVATION

















When you first boot up the device, you will be greeted by the setup wizard. Simply follow the instructions to enable Google, security, time, and other services.

COPYING YOUR DATA



When you first boot up the device, you will be greeted by the setup wizard. During this time, you will be asked if you want to copy data from your old device. You will need internet access to proceed, otherwise you may skip this step and continue when you can access the internet. Follow the instructions as it guides you through different methods of transferring data.

DESKTOP

- **Status bar.** Displays quick information such as alerts and notifications below:













	Battery status		Hotspot is enabled
	Battery charging		Data Saver is enabled
	Battery saver mode		Bluetooth is active
	Do not disturb		Paired with a Bluetooth device
	Do not disturb (Total silence)		Network signal*
	Vibrate		No signal
	microSD card detected		Location active
	Available Wi-Fi networks		Airplane mode
	Connected to a Wi-Fi network		

- P. **Quick Settings.** Provides quick accessibility to essential tablet settings and tablet notifications. To access the Quick Settings, from the top of the screen, drag the status bar downwards. You can expand the pane by tapping  or swiping downwards again to view all accessible settings.

You may also add or remove notifications icons displayed using the Edit icon () or access the tablet's settings with the Settings icon ()

Below is a list of icons and their corresponding notification:

Icon	Notification
	Wireless <ul style="list-style-type: none">▪ Displays the Wi-Fi your tablet is connected to.▪ Tap to enable/disable Wi-Fi or tap Wi-Fi to show other Wi-Fi networks within range.

		<ul style="list-style-type: none"> ▪ Tap and hold to open Wi-Fi settings.
	Bluetooth	<ul style="list-style-type: none"> ▪ Tap to enable Bluetooth or tap Bluetooth see all devices you have paired with your tablet. ▪ Tap and hold to view all available Bluetooth devices within range.
	Do not disturb	<ul style="list-style-type: none"> ▪ Displays the Do not disturb option mode being used. ▪ Tap to enable or disable the selected Do not disturb option mode or tap Do not disturb to show other modes available. ▪ Tap and hold to open the Do not disturb preferences.
	Auto-rotate	<ul style="list-style-type: none"> ▪ Tap to toggle your tablet screen's orientation between Auto-rotate and Portrait mode. ▪ Tap and hold to open the Display settings.
	Battery saver	<ul style="list-style-type: none"> ▪ Tap to enable Battery saver mode. ▪ Tap and hold to open Battery settings.
	Airplane Mode	<ul style="list-style-type: none"> ▪ Tap to toggle Airplane mode on or off. ▪ Tap and hold to access the Network & Internet settings.
	Screen Cast	<ul style="list-style-type: none"> ▪ Tap to cast your tablet's screen on compatible device. ▪ Tap and hold to open the Cast settings
	Hotspot	<ul style="list-style-type: none"> ▪ Tap to toggle the Hotspot feature on or off. ▪ Tap and hold to open the Hotspot and Tethering settings.
	Data Saver	<ul style="list-style-type: none"> ▪ Tap to toggle the Data Saver function on or off. This will prevent the apps you have identified to send and/or receive data in background while enabled. ▪ Tap to access your tablet's Data usage settings.
	Location	<ul style="list-style-type: none"> ▪ Tap to toggle the Location function on or off. ▪ Tap and hold to open the Location settings.
	Invert colors	<ul style="list-style-type: none"> ▪ Tap to toggle between normal and inverted color mode. ▪ Tap and hold to open Accessibility settings.
	Night Light	<ul style="list-style-type: none"> ▪ Tap to toggle Night Light on or off. ▪ Tap and hold to open the Night Light settings.
	Nearby Share	Tap to access the Google Nearby app.

Q. Dock. Use the Dock for immediate accessibility over the applications you commonly use. Depending on the docked app, you may long press on a docked app to do any of the following:

- **✕ Remove.** Remove an app shortcut from the dock.
- **📑 Add Widget.** Add the docked app's widget (if available) to your Desktop.
- **ⓘ App Info.** View an app's info.
- **✎ Edit Shortcut.** Edit app shortcut properties such as its label and swipe action.
- **Other actions.** Some apps offer an extended action (e.g. new conversations for messages, etc.).

R. Home navigation. Primary navigation across all apps.

- **◀ Return.** Returns to the previously opened screen or hides active windows.
- **○ Home.** Tap to go back to the Desktop. Tap and hold this button to open Google Assistant.
- **☐ Used apps.** Display all recently opened applications. You may close all opened apps by tapping on **CLEAR ALL** or open apps in split view by tapping on an app in the list and dragging it upwards. You may also close a specific app by tapping the corresponding **✕** icon of the app.

S. Applications Drawer. Display all applications installed on your tablet. To access the Applications menu, from the Dock, simply swipe upwards. Aside from tapping an icon to launch an app, you may also tap and hold on an app to open other app options and actions.

ENTERING CHARACTERS OR TEXT

The Gboard keyboard will automatically open whenever tapping on any input / text field. [Learn more about the Gboard](#)

6. CONFIGURING YOUR TABLET

CUSTOMIZING THE DESKTOP

APP SHORTCUTS

Adding / Removing app shortcuts

Make your most used apps immediately accessible by adding these as app shortcuts in your Desktop.

- To add new app shortcuts to the Desktop, simply tap and hold any app on the application drawer then drag it to the preferred Desktop area.
- To remove an application shortcut, tap and hold an app shortcut and then tap **X**.

Grouping app shortcuts

To group multiple app shortcuts in a single folder on the Desktop, tap and drag the app shortcut to the app shortcut you want to group it with. Tap the Unnamed Folder, and then tap its name to assign a new name.

CHANGING THE WALLPAPER

Customize the look of your tablet with presets or your custom wallpaper.

1. Tap and hold anywhere on the Desktop, and then tap **Wallpapers**.
2. Select the preferred source of the image to be used as wallpaper.
3. Select whether the wallpaper will appear at the center, left, or right edges.
4. Tap **Set Wallpaper**, and then tap the screens you want it to be applied to.

USING WIDGETS

Widgets are smaller versions of the applications you commonly use on your tablet which you can add in to your Desktop for quick function accessibility.

1. Tap and hold on the Desktop and then tap Widgets ().
2. Tap and hold on the preferred widget, and then drag it to the desired location.

EXPLORING YOUR TABLET'S SETTINGS

Accessible from the applications drawer, the Settings app enables you to customize and control your tablet's overall properties.

NETWORK & INTERNET

Manage and configure various network and connectivity settings

Wi-Fi

Connect your tablet to a wireless network within the area.

Connecting to a wireless network

To connect your tablet to a wireless network:

1. From the Desktop, swipe up to show the Applications drawer, and then go to **Settings > Network & Internet > Wi-Fi**.
2. Toggle **Wi-Fi** on. The tablet will automatically start scanning for wireless networks within the area. To refresh the list, simply swipe downwards.

Note: You may also access the Wi-Fi settings page through the Quick Settings. Tap and hold the Wi-Fi icon on the Quick Settings to have your tablet scanning for available wireless networks.

3. Tap the wireless network you want to connect to then enter the required password (if any).

Note: Once connected, your tablet would automatically connect to the wireless network whenever the tablet's Wi-Fi is on and the wireless network is within reach.

Manually connecting to a wireless network

If you want to manually connect your tablet to a hidden wireless network:

1. From the Desktop, swipe down to show the Applications drawer, and then go to **Settings > Network & Internet > Wi-Fi**.
2. Toggle **Wi-Fi** on.
3. At the bottom of the scanned wireless networks list, tap **+ Add network**, and then enter the required details needed.

Note: This can also be done under Network & Internet > Wi-Fi > Saved networks > Add network.

Wi-Fi Preferences

Enable public network availability notification, install certificates, use various Wi-Fi features, and view other network properties such as MAC and IP addresses.

Wi-Fi Data Usage

Monitor and set data usage restrictions across all applications, as well as set necessary notifications or warnings when your preferred data limit has been reached.

Setting a data usage warning

You may set a data limit warning to help you avoid excessive data usage.

1. From the Desktop, swipe up to show the Applications drawer, and then go to **Settings > Network & Internet > Data usage**.

2. Tap the **Usage** bar and then enter the desired data usage limit. You may change the unit to Mbyte or Gbyte depending on the size of the desired limit.
3. Tap **SET** to save the new Data warning limit.

Using Data saver

Reduce overall data usage by preventing the apps you have set to sending and/or receiving data in background.

1. From the Desktop, swipe up to show the Applications drawer, and then go to **Settings > Network & Internet > Data usage**.
2. Tap **Data saver** and toggle it on.
3. Tap **Unrestricted data**, and toggle on the applications which you want to have restricted data access.

Note: You may also include system apps on the list by simply tapping on , and then tapping on Show system.

Airplane Mode

Use Airplane mode to disable all connectivity functions on your tablet such as Wi-Fi, network data, and Bluetooth. To toggle Airplane mode on or off, you can either do any of the following:

- From the Desktop, swipe up to show the Applications drawer, and then go to **Settings > Network & Internet > Airplane mode**.
- From the Desktop, fully expand the Quick Settings, and then tap **Airplane mode**.

Hotspot & Tethering

Utilize the tethering and wireless hotspot options of your tablet. From the Desktop, swipe up to show the Applications drawer, and then go to **Settings > Network & Internet > Hotspot & Tethering**.

Note: Using any of these features may significantly affect overall battery usage.

- **USB tethering.** Share your tablet's internet connection to a connected USB host.
- **Wi-Fi hotspot.** Share your tablet's internet connection by making your tablet into a Wi-Fi hotspot. The Wi-Fi hotspot's settings can be modified through the **Set up Wi-Fi Hotspot** option.
- **Bluetooth tethering.** Share your tablet's internet connection via Bluetooth.
- **Ethernet tethering.** Share your tablet's internet connection via Ethernet.

VPN

Set up, connect, and/or manage your own VPNs (Virtual Private Networks).

Note: A lock screen pin or password is required before you can use this feature.

To add a VPN profile:

1. From the Desktop, swipe up to show the Applications drawer, tap **Settings**, and then go to **Network & Internet >VPN**.
2. Tap the **+** button, and then correctly enter the needed details on the Edit VPN profile fields provided. The new profile will be added into the VPN list.

To edit a VPN profile:

1. From the Desktop, swipe up to show the Applications drawer, tap **Settings**, and then go to **Network & Internet >VPN**.
2. Tap the corresponding settings icon () of the VPN profile that you want to edit, and then change the fields needed.
3. Tap **Save** to apply the changes or **Forget** to delete the VPN profile.

To connect or disconnect from a VPN profile

1. From the Desktop, swipe up to show the Applications drawer, tap **Settings**, and then go to **Network & Internet >VPN**.
2. Tap the **VPN profile** you want to connect to and then enter the needed details.
3. Tap **Connect**.

Note: To disconnect from the VPN, tap the active VPN profile and then tap Disconnect.

CONNECTED DEVICES

Manage your tablet's features in connecting with other devices.

Bluetooth

Securely pair your tablet with a Bluetooth device.

Configuring the Bluetooth settings

Securely pair your tablet with a nearby Bluetooth device.

1. From the Desktop, swipe up to show the Applications drawer, and then go to **Settings > Connected devices > Bluetooth**.
2. Toggle Bluetooth on to do any of the following:
 - **Pair new device.** Scan for available Bluetooth devices you can pair with.

- **Device name.** Rename the tablet's displayed Bluetooth device name.
- **Received files.** Open the folder of all the files your tablet has received via Bluetooth.
- **tablet's Bluetooth address.** View the Bluetooth's MAC address.

Pairing your tablet with a Bluetooth device

To pair your tablet with a Bluetooth-enabled device:

1. Enable the Bluetooth device that you want to pair with your tablet.

Note: Remember the Bluetooth name of the device you want to pair with your tablet and make sure that the device is discoverable / visible to other Bluetooth devices.

2. From the Desktop, swipe up to show the Applications drawer, tap **Settings**, and then go to **Connected devices > Bluetooth**.

Note: You may also access the Bluetooth settings page through the Quick Settings. Simply long tap on the Bluetooth icon from the Quick Settings to open your tablet's Bluetooth settings.

3. Tap **Pair new device** and then tap the device that you want to pair your tablet with and confirm that you want to pair your tablet with the selected device.

Note: Some devices may require a Bluetooth pairing code which you may have to confirm on both devices.

4. The device will automatically pair and added to the **Paired devices** list.

Note: If the device you paired with is nearby and discoverable, and your tablet's Bluetooth is enabled, your devices would automatically pair with each other and/or will be readily accessible.

Changing Bluetooth device permissions

Once you have paired a Bluetooth device with your tablet, you may change the usage permissions of the paired device.

1. On the **Bluetooth > Paired devices** list, tap the corresponding  icon of the device that you want to have the usage permissions changed.
2. Tap any of the usages that you want the paired device to be used for. Do take note that the usages listed below may vary for each device:
 - **Contact sharing.** Share tablet contacts with the Bluetooth device.
 - **Internet access.** Use the connected Bluetooth device for internet connectivity.
 - **Media audio.** Use the connected Bluetooth device for media audio.
 - **tablet audio.** Use the connected Bluetooth device for tablet calls.

Disconnecting a Bluetooth device

To disconnect a Bluetooth device from your tablet:

1. On the **Bluetooth > Paired devices** list, tap the connected Bluetooth device that you want to disconnect from your tablet.
2. Tap **OK** on the Disconnect prompt to confirm. The device will disconnect from your tablet.

Forgetting a Bluetooth device

To remove a Bluetooth device from the paired devices list:

1. On the **Bluetooth > Paired devices** list, tap the corresponding  icon of the device that you want to unpair with your tablet.
2. Tap **Forget** to remove the device from the list.

Note: You would need to pair your tablet again with Bluetooth device if you want to connect your devices again.

Cast

Mirror your tablet's display on wireless projection capable devices. Do take note that experience may vary from one screen to another, as some devices aren't specifically designed for casting.

1. Make sure that your tablet and the device you will mirror to are connected to the same network.
2. From the Desktop, swipe up to show the Applications drawer, and then go to **Settings > Connected devices > Cast**.
3. On the list of available devices, select your device from the list and wait for your tablet to mirror its screen on the selected device.

Printing

Manage your tablet's printing options.

USB

Change your tablet's USB function when connected to a USB host device via USB cable to any of the following functions:

- **Charge this device.** Only charges your tablet when connected to a USB host.
- **Supply power.** Charge a connected USB host device.
WARNING: This function will only work on devices that support USB Charging.
- **Transfer files.** Transfer files to and from a USB host device. Your tablet's internal and external storage will be accessible to the host device.
- **Transfer photos.** Transfer photos to and from the USB host device and vice versa. Only the image folders in your tablet's internal and external storage will be accessible to the host device.

- **MIDI.** A function for USB-based external MIDI devices.

APPS

Individually manage the notifications provided by each app.

All Apps

View, disable, manage, or set default applications installed in your tablet.

1. From the Desktop, swipe up to show the Applications drawer, and then go to **Settings > Apps > All apps**.
2. Select any app installed in your tablet then view, change, or use the following options or settings below:
 - **Open.** Open the selected app.
 - **Disable.** Uninstall or disable an app. You may only disable pre-loaded applications.
 - **Force stop.** Stop the operation of the selected app. This is useful when an app is misbehaving and/or if you want to restart the selected app.

Default Apps

Set an app as the default app when supported files or links are opened. From the Desktop, swipe up to show the Applications drawer, and then go to **Settings > Apps > Default apps**.

Screen time

View your daily screen time per app, notifications received, times the app was opened and set timers for your apps. To access this area, from the Desktop, swipe up to show the Applications drawer, and then go to **Settings > Apps > Screen time**. Use the following Dashboard settings below:

- **Dropdown bar.** Tap the dropdown bar to change viewing Screen time, Notification received, or Times opened.
- **App timer.** Choose any of the listed apps then select **App timer** to set a daily usage limit for that app.

Unused Apps

View unused apps installed in your tablet. To access this area, from the Desktop, swipe up to show the Applications drawer, and then go to **Settings > Apps > Unused apps**.

Special app access

Control how each or all apps can access your tablet's features, hardware, and/or data. To access this area, from the Desktop, swipe up to show the Applications drawer, and then go to **Settings > Apps > Special app access**. You may then customize each app access below:

- All files access. Enable an app from reading, modifying, and deleting files on your tablet or any connected storage device.
- **Device admin apps.** View or deactivate apps on your tablet that have device administrator privileges.
- **Display over other apps.** Enable an app to run over other apps.
- **Do Not Disturb access.** Permit an app to send out notifications even when Do Not Disturb mode is active.
- **Media management apps.** Allow an app to manage media files including modifying and deleting files created by other apps.
- **Modify system settings.** Enable an app to modify system settings.
- **Device & app notifications.** Allow an app to show notifications.
- **Picture-in-picture.** Enable an app to create a Picture-in-picture window while the app is open or after leaving it, allowing the app's window to display on top of other apps as you use it.
- **Premium SMS access.** Permit an app to have access on SMS.
- **Unrestricted data.** Allow an app to have full access on network data even with Data Saver active.
- **Usage access.** Enable an app to track what apps you're using and how often.
- **Install unknown apps.** Set an app as a trusted source when installing unknown apps.
- **Alarms & reminders.** Allow an app to set alarms and schedule time-sensitive actions.
- **Usage access.** Permit an app to track app usage and frequency of use.
- **VR helper services.** Enable an app to run in virtual reality mode.
- **Wi-Fi control.** Allow an app to turn on, connect to, add, remove, or start a network access.

NOTIFICATIONS

View notifications and manage the behavior of the selected app's notifications.

Configuring each app's notifications

1. From the Desktop, swipe up to show the Applications drawer, and then go to **Settings > Notifications > App settings**.
2. Tap the app that you want to customize. You may configure any of the following:
 - **On.** Enable or disable all notifications from this app.
 - **Allow notification dot.** Enable or disable notification dot display on the app's icon.
 - **Categories.** Toggle on/off or configure other available services within the app which show notifications. Categories may vary for each app.

Notification history

Your recent and snoozed notifications will appear under this area. To access this option, from the Desktop, swipe up to show the Applications drawer, and then go to **Settings > Notifications > Notification history**.

Conversations

Your marked, priority, or any modified conversations will appear under this area. To access this option, from the Desktop, swipe up to show the Applications drawer, and then go to **Settings > Notifications > Conversations**.

Bubbles

Enable some conversations will appear as floating icons on top of other apps. To access this option, from the Desktop, swipe up to show the Applications drawer, and then go to **Settings > Notifications > Bubbles**.

Device & app notifications

Allow apps and devices to read notifications. To access this area, from the Desktop, swipe up to show the Applications drawer, and then go to **Settings > Notifications > Device & app notifications**.

Notifications on lock screen

Enable apps and devices to show conversations and notifications while the device is locked. To access this area, from the Desktop, swipe up to show the Applications drawer, and then go to **Settings > Notifications > Notifications on lock screen**. You have the option to show all, hide silent conversations and notifications, or don't show any notifications.

Sensitive Notifications on lock screen

Allow content to show on the lock screen. To access this area, from the Desktop, swipe up to show the Applications drawer, and then go to **Settings > Notifications > Sensitive Notifications**.

Do Not Disturb

When enabled you will only get notified by important people or apps during a set schedule. To access this option, from the Desktop, swipe up to show the Applications drawer, and then go to **Settings > Notifications > Do Not Disturb**.

Wireless emergency alerts

Control which alerts your tablet can receive and customize other alert preferences. To access this area, from the Desktop, swipe up to show the Applications drawer, and then go to **Settings > Notifications > Wireless emergency alerts**.

On the **Alerts** section, you may tap on any of the options below to do following:

- **Extreme threats.** Enable or disable major threats to life and property alerts.

- **Severe threats.** Enable or disable severe threats to life and property alerts.
- **AMBER alerts.** Enable or disable child abduction emergency bulletins.
- **Test alerts.** Enable or disable to receive carrier tests and monthly tests from the safety alert system
- **Emergency alert history.** View active alerts in your area.

On the **Alerts preferences** section, you may tap on any of the options below to do following:

- **Vibration.** Toggle tablet vibration on/off when receiving alerts.
- **Alert reminder.** Disable alert reminders or change how often a received alert will remind you.

Hide silent notifications in status bar

Allow content to show on the lock screen. To access this area, from the Desktop, swipe up to show the Applications drawer, and then go to **Settings > Notifications > Sensitive Notifications**.

Allow notification snoozing

Allow content to show on the lock screen. To access this area, from the Desktop, swipe up to show the Applications drawer, and then go to **Settings > Notifications > Sensitive Notifications**.

Notification dot on app icon

Enable or disable notification dot display on the app's icon. To access this area, from the Desktop, swipe up to show the Applications drawer, and then go to **Settings > Notifications**.

Enhanced notifications

Allows the device to suggest replies, changes, and other actions. To access this area, from the Desktop, swipe up to show the Applications drawer, and then go to **Settings > Notifications**.

BATTERY

Monitor and manage the battery consumption on your device. From the Battery area, you can see the current battery percentage and charging status. Other options listed below are also available:

Performance Mode

Enables the device to provide better performance in most scenarios but at the cost of more power consumption. To access this area, from the Desktop, swipe up to show the Applications drawer, and then go to **Settings > Battery > Performance Mode**.

Battery Usage

Monitor the device's battery consumption based on the mode used and for each application used since the tablet has been fully charged. To access this area, from the Desktop, swipe up to show the Applications drawer, and then go to **Settings > Battery > Battery Usage**.

Battery saver

Battery saver is designed to automatically reduce the performance, background activity, and other features when it is enabled.

1. From the Desktop, swipe up to show the Applications drawer, and then go to **Settings > Battery > Battery Saver**.
2. Toggle **Battery Saver** on. This can also be done through the Quick Settings.
3. Tap **Set a schedule > Based on percentage**. Set the slider to a desired percentage as to when to activate the feature.
4. Tap **Turn off when charged** to automatically return the tablet to its original performance state and turn on other features when the battery is above 90%.

Battery Manager

Manage the device's battery consumption by detecting which apps consume the most power. To access this area, from the Desktop, swipe up to show the Applications drawer, and then go to **Settings > Battery > Battery Manager**.

Battery Percentage

Toggle battery percentage on the status bar on or off. To access this area, from the Desktop, swipe up to show the Applications drawer, and then go to **Settings > Battery > Battery Percentage**.

STORAGE

View and manage the internal and portable storages of your tablet.

Storage manager

Allows you to view and manage your internal and external storage. You can automatically remove photos and videos from your device depending on how long these have been stored on your tablet. To do so, simply follow these steps:

1. From the Desktop, swipe up to show the Applications drawer, and then go to **Settings > Storage**.
2. Toggle the **Storage manager** on/off.
3. Tap **Storage manager** then tap **Remove photos and videos** to change the required number of days before a photo or video will be deleted.

SOUND

Adjust system volume and other sounds for your tablet.

System volume

1. From the Desktop, swipe up to show the Applications drawer, and then go to **Settings > Sound**.
2. Use the sliders for Media, Alarm, and Notification volume to individually adjust each setting as preferred.

Do Not Disturb

Allow or mute specific notifications and other alerts according to your preferred time or schedule. To access this area, from the Desktop, swipe up to show the Applications drawer, and then go to **Settings > Sound**.

Media

Enable to keep media player open in Quick Settings to easily resume playback. You may also activate media recommendations. To access this area, from the Desktop, swipe up to show the Applications drawer, and then go to **Settings > Sound > Media**.

Customizing ringtones, sounds, and vibrations

Change the system ringtones, sounds, and other vibration settings.

1. From the Desktop, swipe up to show the Applications drawer, and then go to **Settings > Sound**.
2. Select your preferred ringtone for any of the following sound settings:
 - **Default Notification sound.** Default ringtone for all notifications.
 - **Default alarm sound.** Default ringtone for all alarms.
3. From here, you may also enable any of the following settings:
 - Screen locking sound
 - Charging sounds and vibration
 - Touch sounds
 - Touch vibration

DISPLAY

Modify your tablet's display settings such as its brightness level, nightlight, wallpaper, font size and other display related settings.

Brightness level

Change the screen's brightness level.

1. From the Desktop, swipe up to show the Applications drawer, and then go to **Settings > Display**.
2. Tap the **Brightness level** to display the luminance slider and increase or decrease the screen brightness as preferred.

Screen refresh rate

Change the screen display's refresh rate.

1. From the Desktop, swipe up to show the Applications drawer, and then go to **Settings > Display**.
2. Tap **Refresh rate** and then select the desired refresh rate from the options provided.

Adaptive brightness

Optimize the brightness level according to the available light of your surroundings.

1. From the Desktop, swipe up to show the Applications drawer, and then go to **Settings > Display**.
2. Toggle **Adaptive brightness** on to automatically optimize your screen's brightness level according to the available lighting.

Lock screen

Change how notifications are displayed on the lock screen.

1. From the Desktop, swipe up to show the Applications drawer, and then go to **Settings > Display > Lock screen**.
2. Tap **Privacy** and then select any of the following options:
 - **Show all notification content.** Display all notification contents.
 - **Show sensitive content only when unlocked.** Hide all notification contents.
 - **Don't show notifications at all.** Disable all notifications.
3. From here, you may also change the following settings:
 - **Add text on lock screen.** Displays a text while the tablet is locked
 - **Show device controls.** Continue to have access controls when locked
 - **Always show time and info.** Keep the lock screen awake while showing the time and other information
 - **Wake screen for notifications.** Turn on the display if there is a new notification alert

Screen timeout

Personalize the amount of time needed before the screen display turns off.

1. From the Desktop, swipe up to show the Applications drawer, and then go to **Settings > Display > Screen timeout**.
2. Select the preferred time of inactivity before the screen will turn off.

Dark theme

Enable to change the color scheme to a darker hue, making it easier to read in the dark. To access this area, from the Desktop, swipe up to show the Applications drawer, and then go to **Settings > Display**.

Font Size and Display Size

Make the items and text on the screen smaller or larger.

1. From the Desktop, swipe up to show the Applications drawer, and then go to **Settings > Display**.
2. Tap the setting that you want to customize.
3. Adjust the slider to increase or decrease the text or display size.

Night light

Tint the tablet screen in amber, making it easier to read in dim lighting.

1. From the Desktop, swipe up to show the Applications drawer, and then go to **Settings > Display > Night light**.
2. Change any of the Night Light's properties listed below:
 - **Schedule.** Set it to turn on using your custom time or when from sunset to sunrise.
 - **Intensity.** Adjust the strength of the Night light tint.

Auto-rotate screen

Enable to turn the screen based on the device's orientation. To access this area, from the Desktop, swipe up to show the Applications drawer, and then go to **Settings > Display**.

Screen saver

Customize the screen display when the tablet is docked and/or charging.

1. From the Desktop, swipe up to show the Applications drawer, and then go to **Settings > Display > Screen saver**.
2. Tap **Current screen saver** to select a screen saver mode from any of the options below:
 - **Clock.** Display an analog or digital clock. Tap the  icon to select which clock type to be displayed and if Night Light will be used.
 - **Colors.** Display a spectrum of changing colors.

- **Photos.** Display pictures from your device or from your Google account, customize the effects and network data to be used.
3. Tap **When to start** to select the required connection when the selected screen saver display.

WALLPAPER

Change the wallpaper of the tablet's lock and Desktop.

1. From the Desktop, swipe up to show the Applications drawer, and then go to **Settings > Wallpaper**.
2. Select the preferred app source of the image to be used as wallpaper, and then select the image to be used.
3. Tap **Set Wallpaper** to use the selected image as your wallpaper.

ACCESSIBILITY

Modify the accessibility features of your tablet designed for physical disabilities. To access the Accessibility menu, from the Desktop, swipe up to show the Applications drawer, and then go to **Settings > Accessibility**.

- **Downloaded Apps.** Allow features and functionalities from apps that are essential to your tablet.
- **Select to speak.** Enable spoken feedback when tapping items. [Learn more about Select to Speak](#)
- **TalkBack.** Provides spoken feedback to help visually impaired users such as describing what you touch, select, and activate. [Learn more about TalkBack](#)
- **Text and display.** Allows you to change display elements on your tablet including text, color, and animations. [Learn more about Text and display](#)
- **Downloaded Apps.** Enable to lower the screen's brightness below the minimum.
- **Dark theme.** Enable to change the color scheme to a darker hue, making it easier to read in the dark.
- **Magnification.** Enable screen magnification option gestures on your tablet. [Learn more about Magnification](#)
- **Accessibility Menu.** Provides a large on-screen menu to lock your device, control volume and brightness, take screenshots, and more. You may also enable Accessibility Menu shortcut and increase the size of the Accessibility Menu buttons from this area.
- **Switch Access.** Enable people with motor impairments control your device using one or more switches to select items, scroll, enter text, and more. [Learn more about Switch Access](#)

- **Timing controls.** Allows you to change the timings for actions such as touch & hold delay, accessibility timeout, and dwell timing. [Learn more about Touch & hold delay](#) or [Learn more about Dwell Timing](#)
- **System controls.** Set your preferred navigation to either gesture or 3-button. You can also enable Auto-rotate screen from here. [Learn more about Auto-rotate screen](#)
- **Vibration & Haptic strength.** Enable ring vibration, Notification vibration, and Touch feedback.
- **Captions.** Enable and configure caption settings such as size, style, and language. [Learn more about Captions](#)
- **Audio adjustment.** Allow switching between mono and stereo audio, and audio balancing.
- **Accessibility shortcuts.** Enable accessibility button, customize the accessibility button and add a shortcut from the lock screen.
- **Text-to-speech output.** Set the properties of the Text-to-speech output. [Learn more about Text-to-speech output](#)

SECURITY

Set the security settings of your tablet.

Google security status

Use Google services in securing your device.

- **Google Play Protect.** Regularly checks your tablet and apps for harmful behavior. [Learn more about Google Play Protect](#)
- **Find My Device.** Enables you to locate your tablet remotely and secure your data if you lost your tablet. [Learn more about Find My Device](#)
- **Security update and Google Play system update.** Check for available updates and follow the onscreen instructions if any. [Learn more about Security & System update](#)

Setting a screen lock

Set a screen lock for your tablet.

1. From the Desktop, swipe up to show the Applications drawer, and then go to **Settings > Security**.
2. Tap **Screen lock**, and then select the preferred screen lock mode:
 - **None.** Removes the screen lock
 - **Swipe.** Unlock the screen by swiping.
 - **Pattern.** Unlock the screen through a pattern you have registered.
 - **PIN.** Use a PIN to unlock the screen.

- **Password.** Use your preferred password to unlock the screen.

Once you have already set a screen lock for your tablet, you may configure other screen lock settings by doing the following:

1. From the Desktop, swipe up to show the Applications drawer, and then go to **Settings > Security**.
2. Tap the  of the **Screen lock**, and configure any of the following options:
 - **Lock after screen timeout.** Set the needed time for the screen lock to activate.
 - **Power button instantly locks.** Allow the power key button to lock your screen.
3. You may now also customize **Lock screen preferences** as seen below:
 - **On the lock screen.** Enable, hide notification content, or disable notifications on the lock screen.
 - **Lock screen message.** Set a lock screen message.

Using the smart lock settings

Once you have set a screen lock for your tablet, you may use other tablet features to conveniently unlock your tablet when needed.

1. From the Desktop, swipe up to show the Applications drawer, and then go to **Settings > Security**.
2. Enter your **device PIN**. You may use any of the following smart lock features below:
 - **On-body detection.** Once unlocked, the tablet will stay unlocked when it is in motion and will automatically lock once set down.
 - **Trusted places.** Use a home address or location you have set to automatically unlock the tablet.
 - **Trusted devices.** Add devices which will automatically unlock the tablet when nearby.

Device admin apps

View or deactivate apps on your tablet that have device administrator privileges.

1. From the Desktop, swipe up to show the Applications drawer, and then go to **Settings > Security**.
2. Tap **Device admin apps**, and then toggle the apps that you want to activate or deactivate.

Encryption & credentials

View and manage credentials and security certificates.

1. From the Desktop, swipe up to show the Applications drawer, and then go to **Settings > Security > Encryption & credentials**.
2. Modify any of the following.
 - **Encrypt tablet.** Encrypt tablet data.
 - **Trusted credentials.** Displays all trusted certificates.
 - **User credentials.** View all credentials stored in your device.
 - **Install a certificate.** Browse and install certificates from the microSD card.
 - **Clear credentials.** Remove all certificates.
 - **Certificate management app.** Select an app to manage certificates.

Trust agents

View or deactivate trust agents on your tablet. A security verification is required for this feature.

1. From the Desktop, swipe up to show the Applications drawer, and then go to **Settings > Security**.
2. Tap **Trust agents**, and then toggle on the trust agents that you want to enable.

App pinning

Pin a specific app on screen, to temporarily block access to your other apps.

1. From the Desktop, swipe up to show the Applications drawer, and then go to **Settings > Security > App pinning**.
2. Toggle **App pinning** on.

*Note: If preferred, you may toggle on the **Lock device when unpinning** option to add an extra layer of security when removing a pinned app.*

Confirm SIM deletion

Erase a downloaded SIM. A security verification is required for this feature.

1. From the Desktop, swipe up to show the Applications drawer, and then go to **Settings > Security**.
2. Toggle **Confirm SIM deletion**, and then toggle on the trust agents that you want to enable.

PRIVACY

Control which apps can send, have permissions, and access to your data. You can also change what appears on your device's screen may it be passwords, notifications, media and more. To access the Privacy menu, from the Desktop, swipe up to show the Applications drawer, and then go to **Settings > Privacy**.

- **Privacy Dashboard.** Show which apps recently used permissions.
- **Permission manager.** Control app access to your data.
- **Show passwords.** Display characters briefly as you type.
- **Notifications on lock screen.** Select whether to show all, don't show sensitive content, or hide all notifications.
- **App content.** Allow apps to send content to the Android system.
- **Show clipboard access.** Show a message when apps access messages, images, or other content you've copied.
- **Autofill service from Google.** Enable Google to keep and automatically fill in your personal information.
- **Google location history.** Allow Google to save where you go with your device as well as manage it from this section.
- **Activity controls.** Choose the activities and info you allow Google to save.
- **Ads.** Enable ad personalization and create a custom advertising experience.
- **Usage & diagnostics.** Share your data with Google to help improve the Android operating system.

LOCATION

View apps that recently accessed location services and control which apps have permission to use it. To access the Location menu, from the Desktop, swipe up to show the Applications drawer, and then go to **Settings > Location**.

SAFETY & EMERGENCY

Add medical information and emergency contacts to help first responders in an emergency. To access the Safety & emergency menu, from the Desktop, swipe up to show the Applications drawer, and then go to **Settings > Safety & emergency**.

- **Emergency information.** Anyone can read this information from your lock screen and dial your emergency contacts by tapping their names without needing to unlock your device.
- **Emergency Location Service.** If supported, your device can automatically send its location to emergency response partners.
- **Wireless emergency alerts.** Enable and manage public alerts, messages, threats, and more.

PASSWORDS & ACCOUNTS

Manage passwords, autofill services, accounts, and automatically sync app data from this section. To access the Passwords & accounts menu, from the Desktop, swipe up to show the Applications drawer, and then go to **Settings > Passwords & accounts**.

DIGITAL WELLBEING & PARENTAL CONTROLS

Manage screen time, app timers, bedtime schedules, and more. To access the Digital Wellbeing & parental controls menu, from the Desktop, swipe up to show the Applications drawer, and then go to **Settings > Digital Wellbeing & parental controls**.

- **Your Digital Wellbeing tools.** Allows you to view how much time you have spent on your device including time for each app, number of times you've unlock the tablet, and number of notifications received.
- **Dashboard.** Set daily timers for most apps. When the app timer ends, the app is paused for the rest of the day.
- **Bedtime mode.** Silence your tablet and change your screen to black and white at bedtime. You will only receive alarm and important call notifications.
- **Focus mode.** Select distracting apps to pause and hide notifications during a specific time.
- **Manage notifications.** Manage the behavior of the selected app's notifications.
- **Do Not Disturb.** Enable notifications for only important people and apps.
- **Heads Up.** Sends you notifications when you're walking outside.
- **Show icon in the app list.** Toggle to show the Digital Wellbeing app icon on the Applications drawer.
- **Parental controls.** Add content restrictions and set other limits to help your child balance their screen time.

GOOGLE

View, access, and manage all Google services and preferences from this section. To access the Google menu, from the Desktop, swipe up to show the Applications drawer, and then go to **Settings > Google**.

SYSTEM

Modify system-oriented tablet features and preferences.

Languages & input

Modify the language used and input settings of your tablet.

Gestures

Set the camera to launch upon pressing the power key twice or change the navigation to use either 3-button or gestures.

Date & time

Configure the date and time settings of your tablet. By default, these are automatically updated through a data service or an active wireless connection. From the Desktop, swipe up to show the

Applications drawer, and then go to **Settings > System > Date & time**. You may then change any of the following settings:

- **Set time automatically.** Toggle to use network provided date and time.
- **Date.** Manually set the date.
- **Time.** Manually set the time.
- **Set time zone automatically.** Toggle to use network provided time zone.
- **Use location to set time zone.** Toggle to use location services to determine the time zone.
- **Time zone.** Manually set the time zone.
- **Use locale default.** Toggle to use the time format based on the location.
- **Use 24-hour format.** Toggle between 12-hour and 24-hour clock format.

Backup

Set up your tablet to back up your data to Google Drive. These includes apps and apps data, call history, contacts, device settings, and SMS.

1. From the Desktop, swipe up to show the Applications drawer, and then go to **Settings > System > Backup**.
2. Toggle **Back up to Google Drive** on to enable automatic backup and then add a backup account through the now visible **Account** option.

Multiple users

Toggle to allow multiple users and share your tablet with other people. Each user will have their own Home screen, account, apps, settings, and more.

Reset options

Erase connectivity, app preferences, or all data from your tablet's internal storage.

1. From the Desktop, swipe up to show the Applications drawer, and then go to **Settings > System > Reset options**.
2. You may then choose any of the following reset options:
 - **Reset Wi-Fi, mobile & Bluetooth.** Reset all network settings.
 - **Reset app preferences.** Reset all disabled apps, default app settings, app notifications, background data restrictions, and other app permissions.
 - **Erase all data (factory reset).** This will erase all data from your tablet's internal storage. This includes your Google account, system and app data, downloaded apps, music, photos, and other user data.

- **Reset settings data.** Return system settings to its default state excluding personal data and protected settings.

3. Confirm your selection.

Hardware feedback

Allow collection of hardware, software type, configuration, and performance data to help Qualcomm Technologies, Inc. to improve next generation device battery life, security, and performance.

SYSTEM UPDATES

View and manage system updates in this section. From the Desktop, swipe up to show the Applications drawer, and then go to **Settings > System Updates**. You may then change any of the following settings:

- **Check for New System Updates.** Manually check for the latest system update.
- **Show system update history.** Display a list of updates that have been installed in your device.
- **Use Software Upgrade Assistant.** Use this tool to install system updates using your computer.
- **Smart updates.** Set a preferred schedule to automatically install updates.
- **System update status.** Show all applied updates on your device.

ABOUT TABLET

View miscellaneous information regarding your device such as basic info, Legal & regulatory, device details, device identifier, and more. To access this section from the Desktop, swipe up to show the Applications drawer, and then go to **Settings > About tablet**.

7. SAFETY AND MAINTENANCE

SAFETY GUIDELINES FOR RAZER EDGE

Every device comes with its own set of safety guidelines. Here's what we recommend for your Razer Edge.

HARDWARE

- Only use the accessories included with your device, and only purchase accessories made and/or approved by Razer.
- If your device's screen gets broken or cracked, approach a qualified servicing personnel for repair.
- Your device's screen is designed to respond to light taps and button presses. Don't excessively tap the screen or press any of its buttons with unnecessary force.
- If you encounter problems using your device and troubleshooting fails, unplug it, and contact the Razer hotline or visit support.razer.com for assistance. Don't service or fix the device on your own. This will void your warranty.

USAGE

- Use your device in an environment with temperatures ranging from 0°C (32°F) to 40°C (104°F). Should temperatures exceed this range, unplug and/or switch off your device and let the temperature return to an optimal range.
- The Razer Edge is made for entertainment. However, do note that downloading/uploading an excessive number of files, streaming online content, enabling your device's GPS or location, and other similar data services, may incur excessive data charges.
- Traffic laws are important. Don't use your device when driving.
- Don't use your device when doing any activity that requires awareness of your surroundings, like walking or jogging.
- Avoid using or turn off your device in areas that prohibit its usage such as aircrafts, gasoline stations, or theaters.

WATER AND DUST

The Razer Edge is rated up to IP52. It is dustproof and designed to withstand short and minimal immersions in water at minimal depths.

- Don't immerse your device in hot water or in any kind of liquid such as, but not limited to: sea or salt water, pool water, and alcoholic beverages.

- Should your device get wet dry it thoroughly with a soft, dry cloth. Ensure your device and USB-C port is fully dry before attempting to charge your device again and/or remove your SD card tray.
- Please note that damages caused by sand and/or liquid will not be covered by the warranty.

BATTERY WARNING

The Razer Edge contains an internal, lithium-ion polymer rechargeable battery. In general, the life expectancy of this battery depends upon its usage. If the battery does not charge after several attempts, it may be non-operational, and you may need to contact customer support. Don't attempt to replace the battery yourself.

Don't open, mutilate, or expose to conducting materials (metal), moisture, liquid, fire, or heat. Doing so may cause the battery to leak or explode, resulting in personal injury. Don't use or charge the battery if it is leaking, discolored, or deformed.

Don't leave the battery discharged or unused for extended periods. When not using your Razer Edge for more than 30 days, store the device in a fully charged state. This will prevent damage to the battery due to an overly discharged state.

CAUTION: RISK OF EXPLOSION IF BATTERY IS REPLACED BY AN INCORRECT TYPE. DISPOSE OF USED BATTERIES ACCORDING TO THE INSTRUCTIONS

Language that communicates the intention of each of the above warnings is included with the product. For non-user-replaceable batteries use the battery warning above and the final USB-IF statement.

SAFETY GUIDELINES FOR RAZER KISHI V2 PRO

In order to achieve maximum safety while using your Razer Kishi V2 Pro, we suggest that you adopt the following guidelines:

Should you have trouble operating the device properly and troubleshooting does not work, make sure to unplug the device (if applicable) and contact the Razer hotline or go to support.razer.com for support.

Your device should slide in and fit snugly into your Razer Kishi V2 Pro. Should you have trouble attaching your tablet to the device, check if you're correctly sliding your tablet's Type C port into the allotted Type C connector. Don't forcefully jam your device into the controller.

Don't take apart the device (doing so will void your warranty) and don't attempt to operate it under abnormal current loads.

Keep the device away from liquid, humidity or moisture. Operate the device only within the specific temperature range of 0°C (32°F) to 40°C (104°F). Should the temperature exceed this range, unplug and/or switch off the device in order to let the temperature stabilize to an optimal level.

MAINTENANCE AND USE

The Razer Kishi V2 Pro requires minimum maintenance to keep it in optimum condition. Once a month, we recommend you detach your tablet from the device, and gently clean the device using a soft cloth or cotton swab to prevent dirt buildup.

POWER NOTICE

This product is intended to be supplied by a Listed Power Adapter or DC power source marked "L.P.S." (or "Limited Power Source"), rated output 5Vdc/2A or 9Vdc/2A, Tma = 50 degree C. If further assistance is needed with purchasing of a power source, please visit [razer.com/contact-us](https://www.razer.com/contact-us)

8. LEGALESE

COPYRIGHT AND INTELLECTUAL PROPERTY INFORMATION

©2022 Razer Inc. All rights reserved. Razer, the triple-headed snake logo, Razer logo, "For Gamers. By Gamers.", "Powered by Razer Chroma" logo and Razer Edge are trademarks or registered trademarks of Razer Inc. and/or affiliated companies in the United States or other countries. All other trademarks and trade names are the property of their respective owners and other company and product names mentioned herein may be trademarks of their respective companies.

Google and Android are trademarks of Google LLC.

Adreno, Qualcomm, Quick Charge, and Snapdragon are registered trademarks of Qualcomm Incorporated.

Razer Inc. ("Razer") may have copyright, trademarks, trade secrets, patents, patent applications, or other intellectual property rights (whether registered or unregistered) concerning the product in this guide. Furnishing of this guide does not give you a license to any such copyright, trademark, patent or other intellectual property right. The Razer Edge (the "Product") may differ from pictures whether on packaging or otherwise. The Razer Kishi V2 Pro (the "Product") may differ from pictures whether on packaging or otherwise. Razer assumes no responsibility for such differences or for any errors that may appear. Information contained herein is subject to change without notice.

LIMITED PRODUCT WARRANTY

For the latest and current terms of the Limited Product Warranty, please visit razer.com/warranty.

LIMITATION OF LIABILITY

Razer shall in no event be liable for any lost profits, loss of information or data, special, incidental, indirect, punitive, or consequential or incidental damages, arising in any way out of distribution of, sale of, resale of, use of, or inability to use the Product. In no event shall Razer's liability exceed the retail purchase price of the Product.

GENERAL

These terms shall be governed by and construed under the laws of the jurisdiction in which the Product was purchased. If any term herein is held to be invalid or unenforceable, then such term (in so far as it is invalid or unenforceable) shall be given no effect and deemed to be excluded without invalidating any of the remaining terms. Razer reserves the right to amend any term at any time without notice.

FCC E-LABEL INFORMATION

RAZER™ EDGE 5G

Model : RZ45-0460VWQ

Verizon SKU : RZ45-0460VZQ

Rated : 5.0V; 3.0A

3.3V-11.0V; 3.0A

United States

FCC ID: RWO-RZ450460

WARNING: Cancer and Reproductive Harm
www.p65warnings.ca.gov

This product complies with
Appliance Efficiency Program:



This equipment is for home use, and has acquired electromagnetic conformity registration, so it can be used not only in residential areas, but also other areas.



Li-ion

Manufacturer: **RAZER INC.**
9 Pasteur, Suite 100, Irvine, CA 92618, USA
MADE IN CHINA

FCC Part 15 Information and Notices

The FCC approved model meets the following requirements. This device complies with part 15 of the FCC Rules. Operation is subject to the following two conditions:

- (1) This device may not cause harmful interference, and
- (2) this device must accept any interference received, including interference that may cause undesired operation.

Note : This equipment has been tested and found to comply with the limits for a Class B digital device, pursuant to part 15 of the FCC Rules. These limits are designed to provide reasonable protection against harmful interference in a residential installation. This equipment generates, uses and can radiate radio frequency energy and, if not installed and used in accordance with the instructions, may cause harmful interference to radio communications. However, there is no guarantee that interference will not occur in a particular installation.

If this equipment does cause harmful interference to radio or television reception, which can be determined by turning the equipment off and on, the user is encouraged to try to correct the interference by one or more of the following measures:

- Reorient or relocate the receiving antenna.
- Increase the separation between the equipment and receiver.
- Connect the equipment into an outlet on a circuit different from that to which the receiver is connected.
- Consult the dealer or an experienced radio/TV technician for help. Pursuant to Part 15.21 of the FCC Rules, you are cautioned that changes or modifications not expressly approved by manufacturer could void your authority to operate the device.

For body operation, this device has been tested and meets FCC RF exposure guidelines when used with any accessory that contains no metal and which provides a minimum separation distance of 5mm between this device and the body of the user. Use of other accessories may not ensure compliance with FCC RF exposure guidelines.

Changes or modifications not expressly approved by the manufacturer could void the user's authority, which is granted by the Federal Communications Commission, to operate this computer.

Important safety instructions

- a) Do not disassemble or open crush, bend or deform, puncture or shred.
- b) Do not modify or remanufacture, attempt to insert foreign objects into the battery, immerse or expose to water or other liquids, expose to fire, explosion or other hazard.
- c) Only use the battery for the system for which it is specified.
- d) Only use the battery with a charging system that has been qualified with the system per CTIA Certification Requirements for Battery System Compliance to IEEE 1725. Use of an unqualified battery or charger may present a risk of fire, explosion, leakage, or other hazard.
- e) Do not short circuit a battery or allow metallic conductive objects to contact battery terminals.
- f) Replace the battery only with another battery that has been qualified with the system per this standard, IEEE-Std-1725. Use of an unqualified battery may present a risk of fire, explosion, leakage or other hazard.
- g) Only authorized service providers shall replace battery. (If the battery is non-user replaceable).
- h) Promptly dispose of used batteries in accordance with local regulations.
- i) Battery usage by children should be supervised.
- j) Avoid dropping the device or battery. If the device or battery is dropped, especially on a hard surface, and the user suspects damage, take it to a service center for inspection.
- k) Improper battery use may result in a fire, explosion or other hazard.
- l) The device shall only be connected to CTIA certified adapters, products that bear the USB-IF logo or products that have completed the USB-IF compliance program.