

IRIS CONNECT

User Manual

Consumer Cellular®

Table of Contents

Getting To Know Your Phone- - - - -	-7
Getting Started- - - - -	-10
Connecting to Mobile Networks- - - - -	-16
Connecting to Bluetooth Devices- - - - -	-16
Connecting to Your Computer via USB- - - - -	-16
Connecting to Virtual Private Networks - - - - -	-18
Sharing Files With Nearby Devices - - - - -	-20
Sharing Your Mobile Data Connection Through Tethering - -	-21
Personalize Your Phone - - - - -	-22
Changing the System Language - - - - -	-22
Setting the Date and Time- - - - -	-22
Using the Notification Panel - - - - -	-22
Changing the Ringtone and Notification Sound - - - - -	-23
Switching to Silent or Vibration Mode - - - - -	-24
Using Do Not Disturb Mode - - - - -	-25
Setting the Home Screen Transition Effect- - - - -	-27

Protecting Your Phone With Screen Locks - - - - -	-28
Using Your Fingerprint- - - - -	-29
Protecting Your Phone With App Pinning - - - - -	-31
Phone Calls- - - - -	-32
Message Options- - - - -	-34
Email- - - - -	-35
Setting Up the First Email Account - - - - -	-35
Checking Your Emails - - - - -	-35
Camera- - - - -	-36
Customizing Camera and Video Settings- - - - -	-37
Google Apps- - - - -	-38
Changing Settings- - - - -	-39
Apps- - - - -	-41
Notifications - - - - -	-41
Battery - - - - -	-41
Storage- - - - -	-41
Sound and vibration- - - - -	-41

Display-	-42
Applying New Wallpapers -	-42
Accessibility-	-42
Security -	-43
Location-	-44
Safety and emergency-	-45
Password and Accounts-	-45
Digital Wellbeing and Parental Controls -	-45
Google-	-46
System-	-46
About Phone -	-47
Safety Precautions-	48
Hearing Aid Compatibility (HAC) regulations for Mobile Phones -	-49
FCC RF Exposure Information (SAR) -	-51
Legal-	-54

Welcome!

Thank you for choosing IRIS CONNECT.

This User Manual will help you get the most out of your new phone. You'll find instructions to help you begin using your device.

If you need more assistance, feel free to contact us by using the contact information listed below. We're always happy to help you!

Need More Information?

Visit our website at Consumer.Cellular.com/Help

Call us at (888) 835-6047

Getting To Know Your Phone

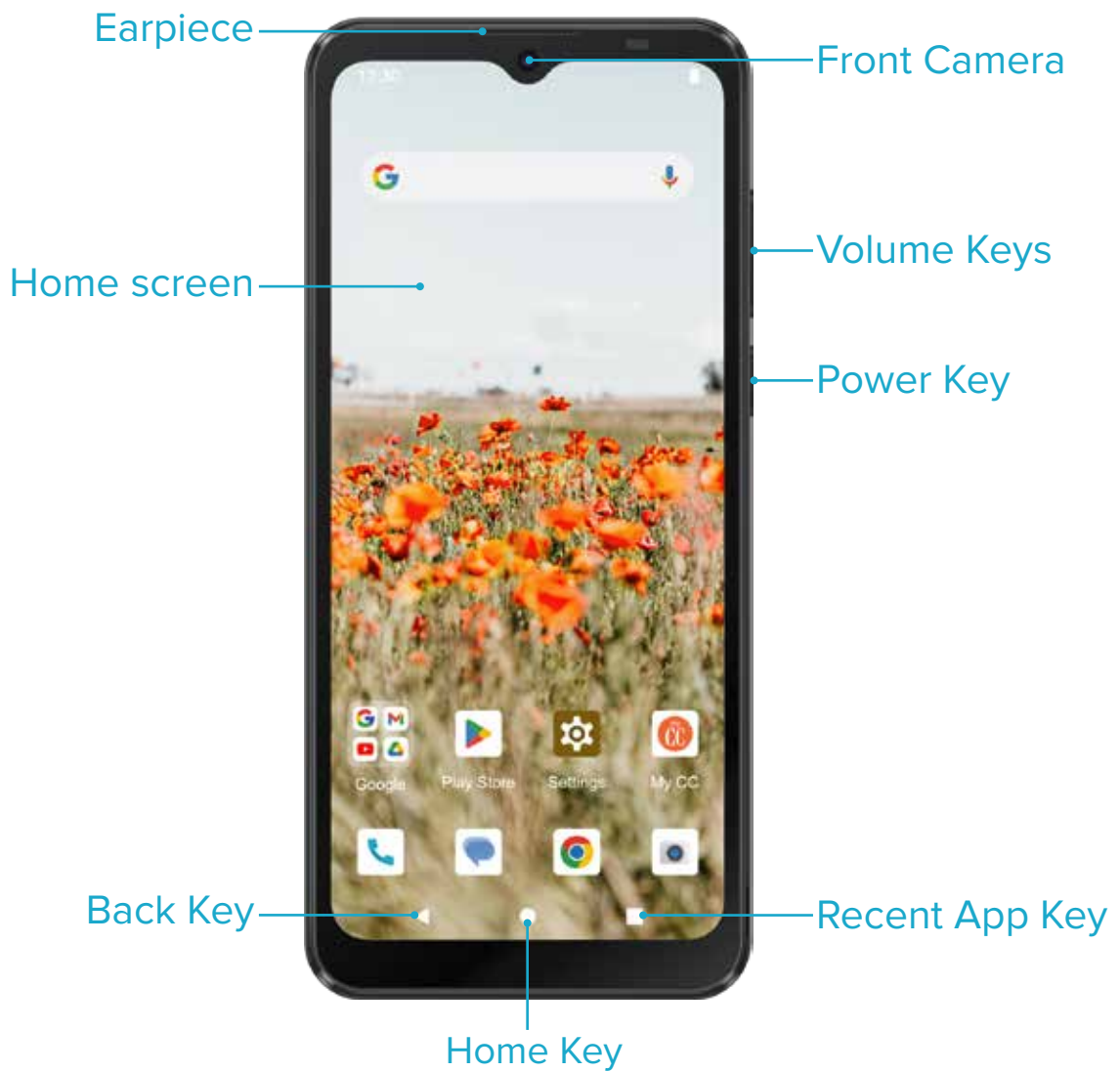
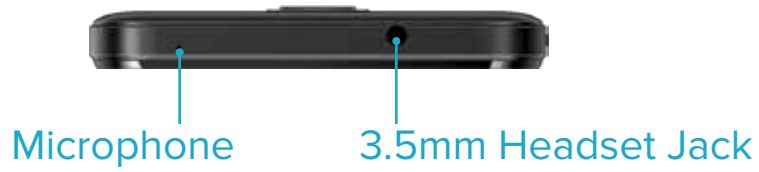



Microphone

Charging/Type-C
USB port



Rear Camera

Flash

Fingerprint Sensor

Battery Cover

Speaker

Key Functions

Key	Description
Power key	Press and hold to power off or restart. Press to turn off or on the screen display. Press and hold the Power Key + volume up to turn off.
Home key	Press to return to the home screen from any application or screen.
Recent apps key	Press to see recently used applications.
Back key	Press to go to the previous screen.
Volume keys	Press or hold to turn the volume up or down.

Getting Started

Initial Setup

The Setup Wizard built into your phone will help guide you through this process.

NOTE: Your setup may be different than the instructions in this User Manual because of software updates or if you choose different options. If the steps are different, just follow your smartphone's on-screen instructions for setup.

Activate the eSIM (electronic SIM)

Your IRIS Connect comes with an eSIM and no physical SIM is needed to activate your service. To activate your eSIM, turn on your phone and follow these steps:

1. Select your language and select the keyboard.
2. Select your Wi-Fi network from the list.
3. Download the eSIM.
4. If Download eSIM fails. If you are prompted to scan a QR code, find it in your Consumer Cellular packing slip or email if purchased at a retailer.

Keep Your Phone Up to Date

Keep your phone up to date and accept available software updates to get new and enhanced features for your phone. Updating the software may also improve your phone's performance.

Charging the Phone

Your phone's battery should have enough power for the phone to turn on, find a signal, and make a few calls. You should fully charge the battery as soon as possible.

IMPORTANT! Use only approved chargers and USB cables.

- 1.Plug cable into phone and wall charger.
- 2.Plug wall charger into a wall outlet.

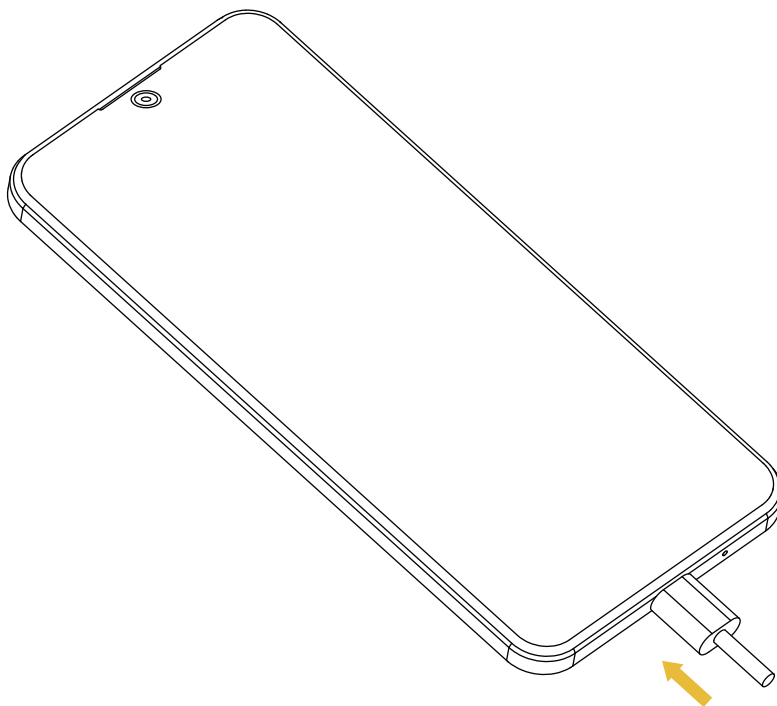

Extending the Battery Life

Active applications, screen brightness levels, Bluetooth and Wi-Fi usage, and GPS functionality can drain your battery. You can follow the helpful tips below to conserve your battery power:

- Reduce the screen backlight time.
- Lower the screen brightness.
- Turn auto-sync, Wi-Fi, and Bluetooth off when not in use.
- Disable the GPS function when not in use. Most applications using this function will periodically query the GPS satellites for your current location; each query drains your battery.
- Use the Battery saver feature.

Installing a memory Card (Not Included)

1. Put your fingernail in the small slot at the bottom of the phone, lift and remove the cover gently.

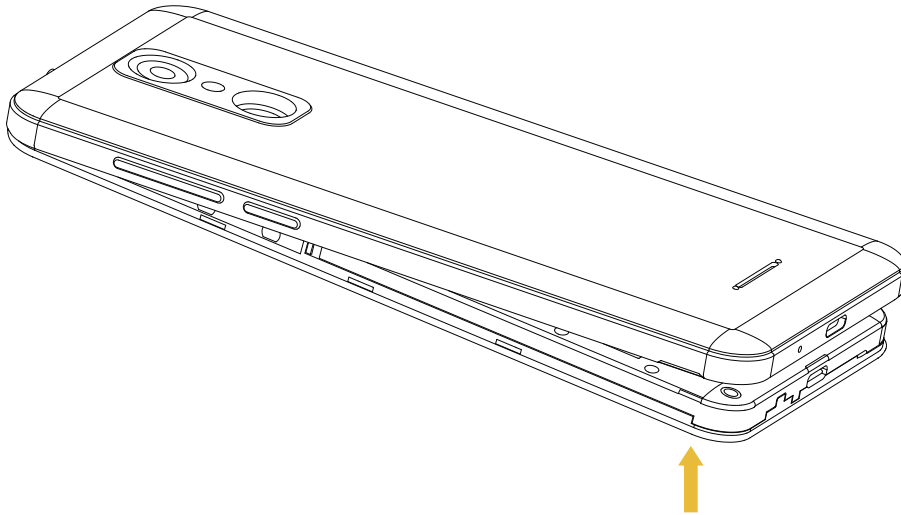

2. Place the memory card in the slot face down and slide it to the right to lock it in place.

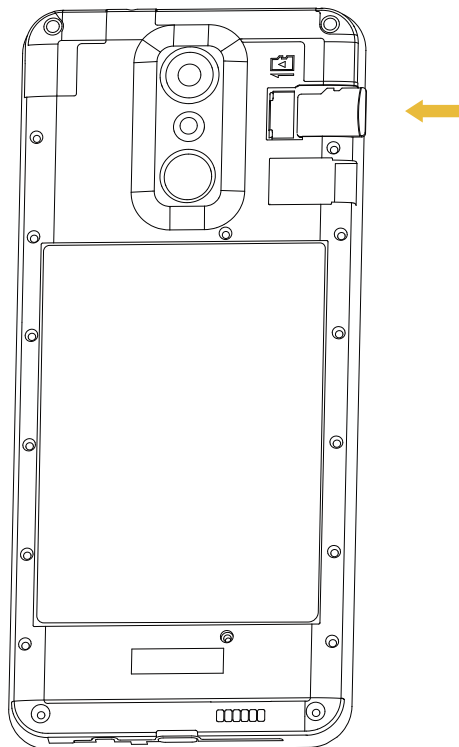

Powering Your Phone On/Off

- Press and hold the **Power Key** on the right side of your phone to turn it on.
- To turn it off, press and hold the **Power Key + volume up** to open the options menu.

NOTE: If the phone freezes or takes too long to respond, press and hold the **Power Key** for about 10 seconds to restart the phone.

Setting Up Your Phone for the First Time

When you first power on your phone after you purchase it or reset it to factory settings, you will need to set it up before using it. First configure Talkback or other accessibility features and tap **Next**, then follow the prompts to set up your language, Wi-Fi, name, protection, Google services, and other options.

Locking/Unlocking the Screen and Keys

Your phone allows you to quickly lock the screen and keys (put the phone into Sleep mode) when not in use and also to turn the screen back on and unlock it when you need it.

Locking the Screen and Keys

To quickly turn the screen off and lock the keys, press the **Power Key**.

NOTE: To save battery power, the phone automatically turns off the screen after a certain period of time when you leave it idle. You will still be able to receive messages and calls while the phone screen is off.

Unlocking the Screen and Keys

1. Press the **Power Key** to turn the screen on.
2. Press and hold a blank area of the screen or the lock icon on the lock screen to unlock the phone.

NOTE: If you have set a fingerprint, an unlock pattern, a PIN, or a password for your phone, you'll need to use your fingerprint, draw the pattern or enter the PIN/password to unlock your screen.

Using the Touch Screen

Your phone's touch screen lets you control actions through a variety of touch gestures.

- **Tap** – When you want to type using the on-screen keyboard, select on-screen items (such as application and settings icons), or press on-screen buttons, simply tap them with your finger.
- **Press and Hold** – To open the available options for an item (for example, an app icon or a link in a web page), press and hold the item.
- **Swipe or Slide** – To swipe or slide means to quickly drag your finger vertically or horizontally across the screen.
- **Drag** – To drag, press and hold your finger with some pressure before you start to move your finger. While dragging, do not release your finger until you have reached the target position.
- **Pinch** – In some apps (such as Maps, web browser, and Gallery), you can zoom in and out by placing two fingers on the screen at once and pinching them together (to zoom out) or spreading them apart (to zoom in).
- **Rotate the Screen** – For most screens, you can automatically change the screen orientation from portrait to landscape by turning the phone sideways.

Connecting to Mobile Networks

1. Swipe up from the bottom of the home screen and tap **Settings**.
2. Tap **Network & internet**.
3. Tap Internet to locate a WiFi network, then tap the network name from the list.
4. Enter the network password and tap **CONNECT**.

Connecting to Bluetooth Devices

1. Swipe up from the bottom of the home screen and tap **Settings** then **Connected Devices**.
2. Tap **Pair new device** to see Bluetooth devices around you.
3. When Bluetooth is on, the icon  appears in the Status Bar.

Connecting to Your Computer via USB

You can connect your phone to a computer with a USB cable and transfer music, pictures, and other files in both directions.

Your phone stores these files in the internal storage or on a removable memory card.

Connecting Your Phone to a Computer via USB

1. Connect your phone to the PC with a USB cable.
2. Choose one of the following options:

- **File transfer:** Transfer files on Windows. Transfer files on Windows® PC or Mac®.
- **USB tethering:** Access Internet on PC by sharing mobile network of your phone.
- **MIDI:** Transfer Windows media to the phone.
- **PTP:** Transfer photos or files if File transfer is not supported by your computer.
- **No data transfer:** Only charge your phone via USB.

Disconnecting Your Phone From the Computer

To disconnect the phone from the computer, simply unplug the USB cable when you're finished.

Connecting to Virtual Private Networks

Virtual private networks (VPNs) allow you to connect to the resources inside a secured local network. VPNs are commonly deployed by corporations, schools, and other institutions to let people access local network resources when not on campus, or when connected to a wireless network.

Depending on the type of VPN you are using, you may be required to enter your login credentials or install security certificates before you can connect to your VPN. You can get this information from your network administrator.

NOTE: You need to set a lock screen pattern, PIN, or password before you can use credential storage (VPN).

Adding a VPN

1. Swipe up from the bottom of the home screen and tap **Settings > Network & internet > VPN**.
2. Tap + and enter the VPN name.
3. Enter the server address and other information provided by your network administrator. Swipe up and check **Show advanced options** to fill out additional details.
4. Tap **SAVE**.

The VPN is added to the list on the VPN screen.

Connecting to a VPN

1. Swipe up from the bottom of the home screen and tap **Settings** > **Network & internet** > **VPN**.
2. Tap the VPN that you want to connect to.
3. When prompted, enter any requested credentials and then tap **CONNECT**.

Modifying a VPN

1. Swipe up from the bottom of the home screen and tap **Settings** > **Network & internet** > **VPN**.
2. Tap beside the VPN that you want to modify.
3. Edit the VPN settings and then tap **SAVE**.

Sharing Files With Nearby Devices

With Nearby Share, you can share photos, videos, and documents with nearby devices via Bluetooth or Wi-Fi.

Turn Sharing On or Off

1. On your phone, make sure Bluetooth, Wi-Fi, and Location are turned on.
2. Open **Settings** and touch **Connected devices > Connection preferences > Nearby Share**.
3. Touch the switch at the top to turn Nearby Share on or off.

Share Content With Someone

1. Open the content, like a photo or webpage on your phone.
2. Find and touch the Share option and then select **Nearby Share**.
3. Touch to turn on if Nearby Share is switched off.
4. Hold your phone and your friend's device which supports the Nearby Share feature close to each other.

NOTE: Make sure both devices are unlocked, and have Nearby Share, Wi-Fi, Bluetooth and location turned on.

5. If prompted, touch the Nearby Share notification on your friend's device to make that device visible to nearby devices.
6. On your phone, your friend's device name will appear and touch the device name to send the content.
7. Accept the sharing on your friend's device.

Set Data Usage for Sharing

1. Open Settings and touch **Connected devices > Connection preferences > Nearby Share**.
2. Touch **Data** and choose one of the following options.
 - **Data:** Mobile data may be used for small files. Charges may apply.
 - **Wi-Fi only:** Never use mobile data to share.
 - **Without internet:** Files will always be shared offline.

Sharing Your Mobile Data Connection Through Tethering

You can use tethering to share your phone's Internet connection with a computer that connects to your phone by Bluetooth or via a USB cable.

NOTE: You cannot transfer files between your phone and the computer when the phone is USB tethered.

1. Open **Settings** and touch **Network & internet > Hotspot & tethering**.
2. Switch on USB tethering or Bluetooth tethering.
 - For USB tethering, connect your phone to the computer with the supplied USB cable before touching USB tethering.
 - For Bluetooth tethering, pair your phone with the computer via Bluetooth and set the computer to obtain its network connection via Bluetooth.

NOTE: To stop sharing your data connection, switch off USB tethering or Bluetooth tethering.

Personalize Your Phone

Changing the System Language

1. Swipe up from the bottom of the home screen and tap **Settings** > **System** > **Languages & input** > **Languages**. The first language in the list is the default system language.

2. Tap **Add a language** to add another language to the list.

3. To change the system language, press and hold next to the language you want and drag it to the top of the list.

NOTE: To remove languages from the list, tap > **Remove** and select the languages you want to delete.

Setting the Date and Time

1. Swipe up from the bottom of the home screen and tap **Settings** > **System** > **Date & time**.

2. Set the date, time, time zone, and time format.

Using the Notification Panel

When you receive new notifications, such as messages or missed calls, icons appear at the top of the screen.

To see more information about the notifications, swipe down from the top of the screen. To close the view, swipe up on the screen.

To change the notification settings of an app, tap **Settings** > **Notifications** > **App notifications**, tap the app name to change the settings.

Changing the Ringtone and Notification Sound

You can quickly customize the default ringtone for incoming calls and the default notification sound.

1. Swipe up from the bottom of the home screen and tap **Settings** > **Sound & vibration**.
2. Tap **Phone ringtone** or **Default notification ringtone**.
3. Scroll through the list and select the ringtone you'd like to use.
4. Tap **OK**.

Adjusting Volumes

1. Swipe up from the bottom of the home screen and tap **Settings** > **Sound & vibration**.
2. Drag the sliders below **Media volume**, **Call volume**, **Ring & notification volume**, and **Alarm volume** to adjust the volume for each type of audio.

NOTE: You can adjust the media volume when a media application is in use by pressing the **Volume** key. If no media application is active, press the **Volume** key to adjust ringtone volume (or the earpiece volume during a call).

Switching to Silent or Vibration Mode

You can set the phone to silent or vibration mode by using one of the following methods.

- Press the **Volume** up/down key when no media application is active to show the volume management window. Drag the slider to the left or keep pressing the **Volume** down key to switch the phone to vibration mode. Press the key again in vibration mode to switch the phone to silent mode.
- Swipe down from the top of the screen to open the Notification Panel and drag the panel downwards. Tap **Sound** or **Vibrate** to switch the phone to vibration or silent mode.

NOTE: To restore normal sound settings, press or hold the **Volume** up key.

Using Do Not Disturb Mode

You can limit interruptions with Do not disturb mode. This mode silences your phone so that it doesn't make sounds or vibrate when you don't want it to.

To turn on Do Not Disturb mode:

1. Swipe up from the bottom of the home screen and tap **Settings > Sound & vibration > Do not disturb**.
2. Tap **TURN ON NOW** or **TURN OFF NOW**.
3. Set the detailed settings.

Set the Exceptions for Do Not Disturb Mode

1. Swipe up from the bottom of the home screen and tap **Settings > Sound & vibration > Do not disturb**.
2. Select the following options and choose what to allow.
 - **People:** Allow calls, messages, or conversations.
 - **Apps:** Choose which apps can send you notifications.
 - **Alarms & other interruptions:** Allow alarms, media sounds, touch sounds, reminders, or calendar events.

Set an Automatic Schedule

You can set automatic schedules to activate Do Not Disturb mode for specific times or events.

1. Swipe up from the bottom of the home screen and tap **Settings > Sound & vibration > Do not disturb > Schedules**.
2. Touch an existing schedule to turn it on or off.
Touch **Add more** to create your own schedules.

Set How Long Do Not Disturb Mode Lasts

1. Swipe up from the bottom of the home screen and tap **Settings > Sound & vibration > Do not disturb > Duration for Quick Settings.**
2. Set how long Do Not Disturb mode will stay on when you turn it on.

Choose Settings for Hidden Notifications

1. Swipe up from the bottom of the home screen and tap **Settings > Sound & vibration > Do not disturb > Display options for hidden notifications.**
2. Set notification behavior in Do Not Disturb mode. You can block sound or visuals from notifications, or customize more restrictions.

Setting the Home Screen Transition Effect

1. Press and hold an empty place on the home screen.
 2. Touch **Home settings**.
 3. Tap an effect and the phone will demonstrate how it works.
- When you have found one you like, press the **Home** key to exit.

Changing Screen Brightness

1. Swipe up from the bottom of the home screen and tap **Settings > Display > Brightness level**.
2. Drag the slider to manually adjust the screen brightness.

Choosing Your Wallpaper

You can set the wallpaper for the home screen or lock screen.

1. Press and hold an empty place on the home screen and then touch **Wallpapers**.
2. Select a preset wallpaper, or touch **Photos** to select a picture and pan and zoom on it to select the area for the wallpaper.
3. Touch **Set wallpaper** and choose where the wallpaper should be used.

Protecting Your Phone With Screen Locks

You can protect your phone by creating a screen lock. When it is enabled, you need to swipe up on the screen, and then draw a pattern or enter a numeric PIN or password to unlock the phone's screen and keys.

1. Swipe up from the bottom of the home screen and tap **Settings > Security**.

2. Touch **Screen lock**.

3. Touch **None, Swipe, Pattern, PIN, or Password**.

- Touch **None** to disable screen lock protection.
- Touch **Swipe** to enable screen lock and allow unlocking with a "swipe" gesture. You can unlock the screen by touching the display and sliding up.
- Touch **Pattern** to create a pattern that you must draw to unlock the screen.
- Touch **PIN** or **Password** to set a numeric PIN or a password that you must enter to unlock the screen.

For Pattern, PIN, or Password lock, select how you would like notifications and their contents to show when the phone is locked. Then tap **DONE**.

NOTE: Remember the pattern, PIN or password you set. Otherwise, you will have to upgrade the phone software to use the phone.

Using Your Fingerprint

With the fingerprint sensor on the back of your phone, you can register fingerprints and use them to unlock the phone, or open a bound app when the screen is off or locked. You can also use swipe functions.

NOTES:

- The fingerprint feature is usable only when a screen lock (Pattern, PIN, or Password) is enabled. When the screen lock is reset to Swipe, all registered fingerprints are erased.
- If you restart your phone, you need to enter the screen lock pattern, PIN or password you set to unlock the screen for the first time.

Register a Fingerprint

1. Swipe up from the bottom of the home screen and tap **Settings > Security > Fingerprint**.
2. Enter the screen lock pattern, PIN or password you set. If you haven't set a screen lock, follow the prompts to set it.
3. Follow the prompts to record the center and the edges of a finger.

NOTE: Touch an existing fingerprint record to change its name or delete it.

Set Fingerprint Functions

1. Swipe up from the bottom of the home screen and tap **Settings > Security > Fingerprint**.
2. Enter the screen lock pattern, PIN or password you set.
3. You can set the following options.
 - Wake up and unlock your phone: Unlock the phone with a registered fingerprint when the screen is off or locked.
 - Simple touch: When the screen is off or locked, you can quickly open a selected app with a registered fingerprint. Each registered fingerprint can be assigned to a different app.

Protecting Your Phone With App Pinning

You can pin an app's screen to keep it in view until you unpin it.

This feature can be used, for example, to let a trusted friend play a specific game.

NOTE: When an app is pinned, the pinned app may open other apps and your personal data may be accessible.

Turn On App Pinning

1. Open Settings and touch **Security > More security settings > App pinning**.
2. Touch the On/Off switch.
3. Read the on-screen prompts and touch **OK**.
4. To add security for unpinning, switch on Lock device when unpinning and set up a screen lock with or without fingerprint as prompted, or switch on Ask for unlock pattern before unpinning, Ask for PIN before unpinning, or Ask or password before unpinning if you've set a screen lock already.

Pin an App

1. Ensure that app pinning is turned on.
2. Open the recent apps list. If the app you want to keep in view is not in recent apps, open it first.
3. Tap the app icon at the top of the screen, and select **Pin**.

Phone Calls

You can place calls from the Phone app, the Contacts app, or other apps or widgets that display contact information.

Wherever you see a phone number, you can usually tap it to dial.

Placing a Call by Dialing

1. From the home screen, tap .

2. Enter the phone number or the contact name with the onscreen keypad. Tap  to delete incorrect digits.

3. Tap  below the keypad to dial.



Ending a Call

During a call, tap  on the screen.

You can also tap the search box at the top of the Phone app screen and enter the phone number or contact name you want to call. Tap the matching contact to place the call.

Working With the Call History

The call history is a list of all the calls you've placed, received, or missed. It provides a convenient way to redial a number, return a call, or add a number to your Contacts.

To open the call history, from the home screen, tap  > 
> Call history.

Call Your Contacts

1. From the home screen, touch  > **Contacts** to view all your contacts.
2. Touch a contact and then touch the number to place a voice call, or to start a Google Meet video call.



Using Voicemail

If you have set the phone to divert calls to voicemail, callers can leave voicemail messages when they cannot reach you.

Here's how to set up and use your phone's voicemail feature.

Setting Up Voicemail

You should set up your voicemail and personal greeting as soon as your phone is activated. Always use a password to protect against unauthorized access.

1. From the home screen, touch  >  .
2. Press and hold the 1 key in the dialer.
3. Follow the voice prompts to create your password, record your name announcement, and record your greeting.

Messages

You can use Messages to exchange text messages (SMS) and multimedia messages (MMS), and chat messages.

Opening the Messages Screen





From the Home Screen, touch .

The Messages screen opens, where you can create a new message, search for messages, or open an ongoing message thread.

- Tap **Start chat** to write a new text or multimedia message.
- Tap  to search for a message using keywords.
- Tap an existing message thread to open the conversation.

Message Options

On the Messages screen, touch and hold a thread and the following options are available.

- Touch  to mark the message.
- Touch  to archive the thread.
- Touch  > **Delete** to delete the thread.
- Touch  > **OK** to block the contact or number in the thread, and the thread will be moved to "Spam & blocked."

Email

Use it to read and send emails from Microsoft Exchange ActiveSync, Gmail, Hotmail, and more.

Setting Up the First Email Account

1. On the Home screen, tap **Email**.
2. Select an email server, and then enter the email address and password.
3. Tap **NEXT** to let the phone retrieve the network parameters automatically.

Follow the on-screen instructions to finish the setup.

Your phone will show the inbox of the email account and start to download email messages.



Checking Your Emails

Your phone can automatically check for new emails at the interval you set when setting up the account.

You can also check new emails manually by swiping down on the message list.

Camera

You can use the camera or video camera to take and share pictures and videos.

1. On the Home screen, tap .
2. Aim the camera at the subject and make any necessary adjustments.
3. Lightly tap  to take the picture.

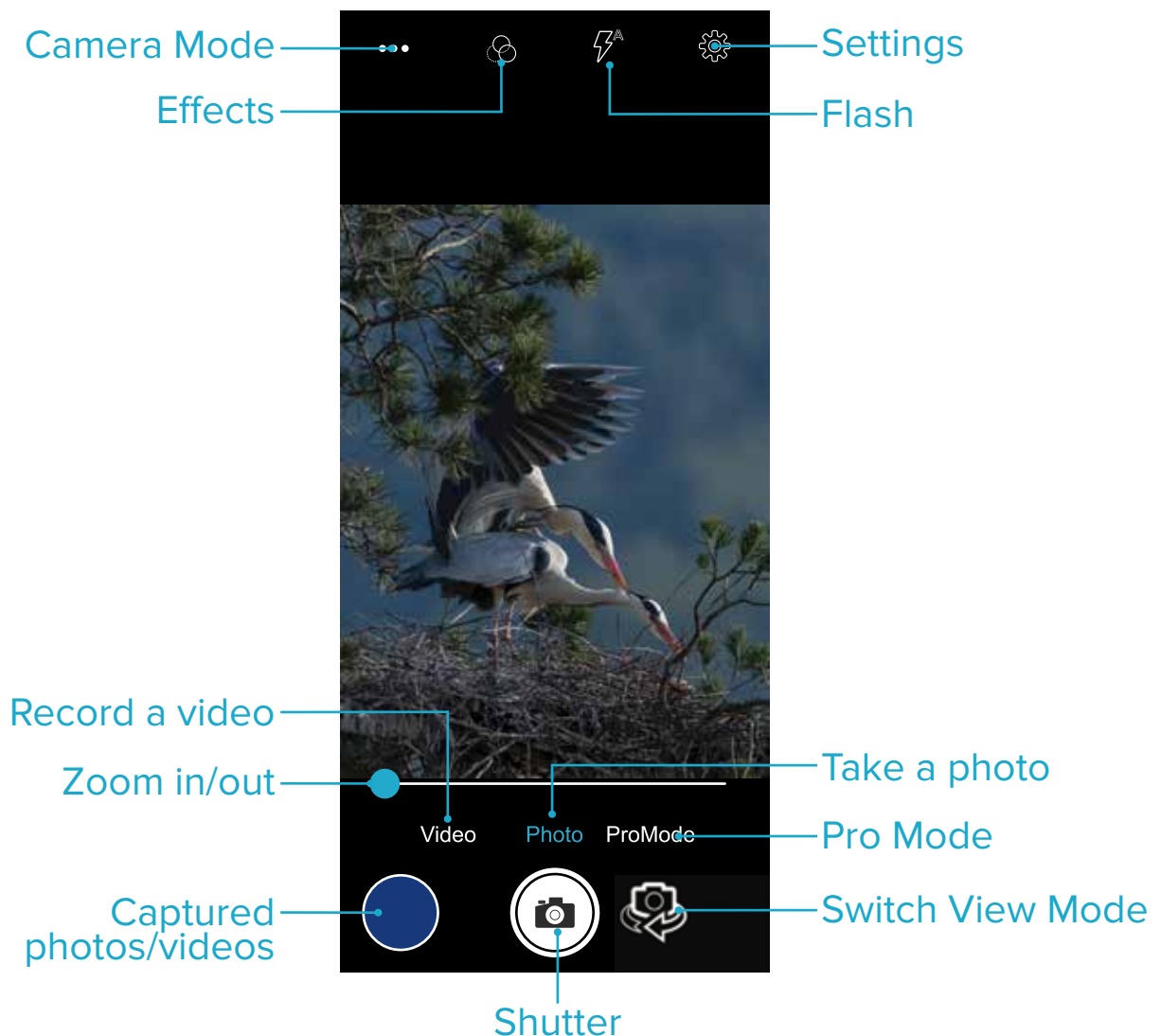

Customizing Camera and Video Settings

Before capturing a photo or a video, you can tap to open the following camera and camcorder setting options.

NOTE: Some camera and video options will change in different camera modes.

• CAMERA

Countdown timer: Set a time delay before the camera takes a picture after you tap the shutter icon, or turns off this feature.

Continuous shot: Turn on to continuous take photo.

Picture size: Set the image size for your photo.

Picture quality: Set the quality for your photo.

Exposure: Set the exposure.

White balance: Choose the white balance.

Shutter sound: Turn on or off the shutter sound.

• VIDEO

Video quality: Set the quality for your video.

Video duration: Set a time duration when you capturing a video.

Image stabilization: Turn on or off the image stabilization.

Noise reduction: Turn to reduce the noise.

Video encoder: Set the video encoder.

Encoder profile: Set the encoder profile.

Audio encoder: Set the audio encoder.

Video rotation: Choose to rotate the video.

Time lapse: Set the time interval between each frame when you shot time lapse videos with the back camera.

Google Apps

Open Settings and touch Google to manage settings for Google apps and services.

NOTE: Some Google services may not be available in your region.

- Chrome: Use the Chrome app to browse the Internet and get your bookmarks, browsing history, and more synced with your Google account.
- Drive: Store files on Google servers for free after you sign in to your Google account. You can access them on your computers, your phones and other devices, share them, or collaborate with others.
- Gmail: Send and receive emails via your Gmail account or other personal email accounts.
- Google: Use Google search or get information when you need it with Google Now.
- Maps: Find your place and find your way in the world.
- Photos: Manage photos on the phone and your Google account.
- YT Music: Play music on the phone and on your Google account.
- Play Store: Purchase and download apps, games, and more from the Google Play Store.
- YouTube: Watch video clips from YouTube.com, or upload your own and share with the world.

Changing Settings

The Settings app contains most of the tools for customizing and configuring your phone.

Network and internet

Wi-Fi

Open Settings and touch **Network & internet > Wi-Fi**. You can turn Wi-Fi on or off and configure your Wi-Fi connections.

Airplane Mode

Open Settings and touch **Network & internet > Airplane mode** to turn Airplane mode on or off. All the phone's radios that transmit voice or data are turned off when airplane mode is on.

Hotspot and tethering

Open Settings and touch **Network & internet > Hotspot & tethering** to share your phone's mobile data connection with PCs or other devices.

Data Saver

Open Settings and touch **Network & internet > Data Saver** to enable or disable Data Saver, which prevents apps from using data connection in the background. Apps you're currently using can access data, but may do so less frequently when Data Saver is enabled. You can touch **Unrestricted data** to allow some apps to always have data connection access, even when Data Saver is enabled.

VPN

Open Settings and touch **Network & internet > VPN** to set up and connect to virtual private networks.

Private DNS

To get information from a website, your phone first asks where the website is. Private DNS is a way to help secure these questions and answers. We recommend keeping Private DNS turned on.

Open Settings and touch **Network & internet > VPN > Private DNS** to turn Private DNS on or off, or change its settings.

Connected Devices

Open Settings and touch **Connected devices > Connection preferences** to use the following features.

- Bluetooth: Turn Bluetooth on or off and configure your Bluetooth connections.
- Printing: Use the default printing service or other printer plug-ins installed from the Google Play Store or your printer manufacturer for wireless printing.
- Chromebook: Link devices so you can text from your computer, share your phone's internet connection and simplify unlocking.
- Nearby Share: Use Bluetooth or Wi-Fi to share contents with other devices near your phone.
- Android Auto: Use apps on your car screen.

Apps

Open Settings and touch Apps. Touch All apps to see all apps installed on your phone and manage them.

Touch an app to see its information and configure the available options.

Notifications

Open Settings and touch Notifications to manage app notifications.

Battery

Open Settings and touch Battery to view the battery level, enable different battery saving modes, check what has been using the battery, and manage apps intelligently or set more options to improve battery life.

Storage

Open Settings and touch **Storage** to view the memory information of the internal phone storage and the microSD card (if one is installed).

When you connect a USB storage device (such as a USB flash) to your phone with an OTG adapter cable, you can view its storage status, unmount it, or erase all data on it.

Sound and vibration

Open Settings and touch **Sound& vibration**. Adjust different types of volume, set Do Not Disturb options, set up ringtone, notification and alarm sound, and set other sounds and vibrations.

Display

Open Settings and touch **Display** to configure the display options, including brightness level, Dark theme, Night Light, wallpapers, screen timeout, auto-rotate screen, lock screen options, etc.

Applying New Wallpapers

You can set the wallpaper for the home screen or lock screen.

1. Open **Settings** and touch **Wallpaper**.
2. Tap **Live Wallpapers**, **Live Wallpapers**, or **Photos**. Select an image or an animation. Some cropping may be needed for **Gallery** and **Photos** images.
3. If necessary, tap **OK** or **SET WALLPAPER**.

NOTE: In addition, you can press and hold an empty place on the home screen, tap **Wallpapers**. Then select a built-in image or a live wallpaper from your Gallery.

Accessibility

Open Settings and touch **Accessibility** to configure accessibility options and services on your phone, such as using color correction or Display size and text for users with sight problems.

Security

Open Settings and touch **Security** to configure options that help keep your phone and data safe.

- **Google Play Protect:** Google Play Protect regularly checks your apps and phone for harmful behavior and warns you about any detected potential harm.
- **Find My Device:** Use Find My Device to locate, lock, or wipe your lost device remotely. The lost device must be signed in to a Google account.
- **Security update:** Check for security update of your system.
- **Screen lock:** Disable the screen lock or enable it with swipe, pattern, PIN, or password.
- **Fingerprint:** Set up fingerprints and enable them to unlock the phone or quickly open a selected app. You can also enable the swipe functions of the fingerprint sensor.
- **More security settings:** Set other security settings.

Privacy

Open Settings and touch **Privacy** to configure the privacy settings.

- **Privacy dashboard:** Show which apps recently used permissions.
- **Permission manager:** Check what apps have been allowed to access certain permissions. You can also change the app permissions.

WARNING! Changing the app permissions may result in the app not working correctly or as originally intended.

- **Show passwords:** Display passwords as you enter them.
- **Notifications on lock screen:** Choose what notification contents will be shown on the lock screen.
- **Show media on lock screen:** Display media player on lock screen.
- **Android System Intelligence:** Get suggestions based on the people, apps, and content you interact with.
- **App content:** Allow apps to send content to the Android system.
- **Show clipboard access:** Show a message when apps access text, images, or other content you have copied.
- **Autofill service from Google:** Set the options of Autofill with Google. With a single touch, you can fill in passwords, addresses, credit cards, and other information saved to your Google account.
- **Advanced:** Set advanced options such as Google location history, activity controls, Ads personalization, and usage & diagnostics.

Location

Open Settings and touch **Location** to manage location services, which help your phone and apps determine your location. To use location-related applications, such as finding your location on Google Maps, you must have location services enabled on your phone.

Safety and emergency

Open Settings and touch **Safety & emergency** to set your personal safety, emergency contacts, emergency SOS and etc.

NOTE: This phone, like any other wireless phone, operates using radio signals, which cannot guarantee connection in all conditions. Therefore, you must never rely solely on any wireless phone for emergency communications.

Password and Accounts

Open Settings and touch **Password & Accounts** to manage your accounts and synchronization. Touch **Add account** to sign in to or create accounts on your phone. Touch an account you have added to adjust its settings.

Digital Wellbeing and Parental Controls

Open Settings and touch **Digital Wellbeing & parental controls** to get information about how you spend time on your phone, like how often you unlock it and how long you use each app. You can use that information to improve your digital wellbeing. You can also help your child balance their screen time with the Family Link app.

Touch Show your data to get information on how you spend time on your phone and apps.

In the **Parental controls** section, touch **Set up parental controls** to add content restrictions and set other limits for your child with the Family Link app.

Google

Open Settings and touch Google to manage settings for Google apps and services.

System

Languages and Input

Open Settings and touch System > Languages and input to configure options related to system language, input methods and assistance, speech output, mouse/trackpad input, and vibration redirection.

Gestures

Open Settings and touch **Gestures**. You can set the phone with special finger gestures, press and hold power key to enable each function or etc.

Date & Time

Open Settings and touch **System > Date & time** to set date, time, time zone, and the time format. You can also use network-provided data.

Backup

Open Settings and touch **System > Backup** to manage data backup options. To easily restore or switch phones at any time, you can enable automatic backup to Google Drive of important data. You need to sign in to your Google account to use this feature.

System Update

Open Settings and touch System > System update to check for system updates and install them when they become available.

Reset Options

Open Settings and touch **System > Reset options** to reset network settings, app preferences, or the phone to factory default status.

About Phone

Open Settings and touch **About phone** to view phone information, SIM card status, legal information, and other information. You can also touch Emergency information to edit your medical information and emergency contacts for first responders to read from your lock screen.

Safety Precautions

- Do not disassemble or open crush, bend or deform, puncture or shred.
 - Do not modify or remanufacture, attempt to insert foreign objects into the battery, immerse or expose to water or other liquids, expose to fire, explosion or other hazard.
 - Only use the battery with a charging system that has been qualified with the system per CTIA Certification Requirements for Battery System Compliance to IEEE 1725. Use of an unqualified battery or charger may present a risk of fire, explosion, leakage, or other hazard.
 - Replace the battery only with another battery that has been qualified with the system per this standard, IEEE-Std-1725. Use of an unqualified battery may present a risk of fire, explosion, leakage or other hazard.
- Only authorized service providers shall replace battery.
(If the battery is non-user replaceable).
- Promptly dispose of used batteries in accordance with local regulations.
 - Avoid dropping the phone or battery. If the phone or battery is dropped, especially on a hard surface, and the user suspects damage, take it to a service center for inspection.
 - Improper battery use may result in a fire, explosion or other hazard.

Hearing Aid Compatibility (HAC) regulations for Mobile Phones

In 2003, the FCC adopted rules to make digital wireless telephones compatible with hearing aids and cochlear implants.

Although analog wireless phones do not usually cause interference with hearing aids or cochlear implants, digital wireless phones sometimes do because of electromagnetic energy emitted by the phone's antenna, backlight, or other components. Your phone is compliant with FCC HAC regulations (ANSI C63.19- 2011). While some wireless phones are used near some hearing devices (hearing aids and cochlear implants), users may detect a buzzing, humming, or whining noise. Some hearing devices are more immune than others to this interference noise and phones also vary in the amount of interference they generate. The wireless telephone industry has developed a rating system for wireless phones to assist hearing device users in finding phones that may be compatible with their hearing devices. Not all phones have been rated. Phones that are rated have the rating on their box or a label located on the box. The ratings are not guarantees. Results will vary depending on the user's hearing device and hearing loss. If your hearing device happens to be vulnerable to interference, you may not be able to use a rated phone successfully. Trying out the phone with your hearing device is the best way to evaluate it for your personal needs.

This phone has been tested and rated for use with hearing aids for some of the wireless technologies that it uses. However, there may be some newer wireless technologies used in this phone that have not been tested yet for use with hearing aids. It is important to try the different features of this phone thoroughly and in different locations, using your hearing aid or cochlear implant, to determine if you hear any interfering noise. Consult your service provider or the manufacturer of this phone for information on hearing aid compatibility. If you have questions about return or exchange policies, consult your service provider or phone retailer.

M-Ratings: Phones rated M3 or M4 meet FCC requirements and are likely to generate less interference to hearing devices than phones that are not labeled. M4 is the better/higher of the two ratings.

T-Ratings: Phones rated T3 or T4 meet FCC requirements and are likely to be more usable with a hearing device's telecoil ("T Switch" or "Telephone Switch") than unrated phones. T4 is the better/higher of the two ratings. (Note that not all hearing devices have telecoils in them.)

Your phone meets the T3/M3 level rating.

Hearing devices may also be rated. Your hearing device manufacturer or hearing health professional may help you find this rating. For more information about FCC Hearing Aid

Compatibility, please go to <http://www.fcc.gov/cgb/dro>.

FCC RF Exposure Information (SAR)

This phone is designed and manufactured not to exceed the emission limits for exposure to radio frequency (RF) energy set by the Federal Communications Commission of the United States.

During SAR testing, this device was set to transmit at its highest certified power level in all tested frequency bands, and placed in positions that simulate RF exposure in usage against the head with no separation, and near the body with the separation of 15 mm. Although the SAR is determined at the highest certified power level, the actual SAR level of the device while operating can be well below the maximum value.

This is because the phone is designed to operate at multiple power levels so as to use only the power required to reach the network. In general, the closer you are to a wireless base station antenna, the lower the power output.

The exposure standard for wireless devices employing a unit of measurement is known as the Specific Absorption Rate, or SAR. The SAR limit set by the FCC is 1.6 W/kg.

This device is complied with SAR for general population / uncontrolled exposure limits in ANSI/IEEE C95.1-1992 and had been tested in accordance with the measurement methods and procedures specified in IEEE1528.

The FCC has granted an Equipment Authorization for this model phone with all reported SAR levels evaluated as in compliance with the FCC RF exposure guidelines. SAR information on this model phone is on file with the FCC and can be found under the Display Grant section of www.fcc.gov/oet/ea/fccid after searching on FCC ID: 2AWF6-SH4650.

For this device, the highest reported SAR value for usage against the head is 1.117 W/kg, and for usage near the body is 1.024 W/kg.

While there may be differences between the SAR levels of various phones and at various positions, they all meet the government requirements.

SAR compliance for body-worn operation is based on a separation distance of 15 mm between the unit and the human body. Carry this device at least 15 mm away from your body to ensure RF exposure level compliant or lower to the reported level. To support body-worn operation, choose the belt clips or holsters, which do not contain metallic components, to maintain a separation of 15 mm between this device and your body.

RF exposure compliance with any body-worn accessory, which contains metal, was not tested and certified, and using such body-worn accessory should be avoided.

FCC Compliance

This device complies with part 15 of the FCC rules. Operation is subject to the following two conditions: (1) this device may not cause harmful interference, and (2) this device must accept any interference received, including interference that may cause undesired operation.

NOTE: The manufacturer is not responsible for any radio or TV interference caused by unauthorized modifications or changes to this equipment. Such modifications or changes could void the User's authority to operate the equipment.

NOTE: This equipment has been tested and found to comply with the limits for a Class B digital device, pursuant to part 15 of the FCC Rules.

These limits are designed to provide reasonable protection against harmful interference in a residential installation. This equipment generates uses and can radiate radio frequency energy and, if not installed and used in accordance with the instructions, may cause harmful interference to radio communications. However, there is no guarantee that interference will not occur in a particular installation.

If this equipment does cause harmful interference to radio or television reception, which can be determined by turning the equipment off and on, the user is encouraged to try to correct the interference by one or more of the following measures:

- Reorient or relocate the receiving antenna.
- Increase the separation between the equipment and receiver.
- Connect the equipment into an outlet on a circuit different from that to which the receiver is connected.
- Consult the dealer or an experienced radio/TV technician for help.

Federal Communication Commission (FCC) Radiation Exposure Statement.

When using the product, maintain a distance of 20cm from the body to ensure compliance with RF exposure requirements.

Legal

Thank you for choosing this IRIS mobile device. In order to keep your device in its best condition, please read this manual and keep it for future reference.

Copyright © 2023 Consumer Cellular, Inc.

All rights reserved.

No part of this publication may be excerpted, reproduced, translated or utilized in any form or by any means, electronic or mechanical, including photocopying and microfilm, without the prior written permission of Consumer Cellular, Inc.

We reserve the right to make modifications on print errors or update specifications without prior notice.

Images and screenshots used in this manual may differ from the actual product. Content in this manual may differ from the actual product or software.

